

DEFENZO **WALLBOX AC**

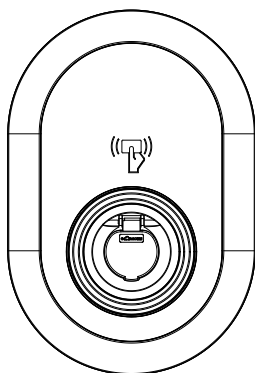

CHARGING STATION

Defenzo Wallbox AC22 Smart

Installation Guide

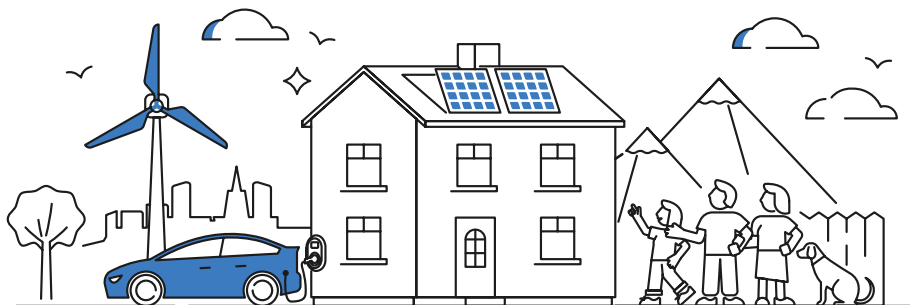

CONTENTS

1 - SAFETY INFORMATION	4
1.1 - SAFETY WARNINGS	4
1.2 - GROUND CONNECTION WARNINGS	5
1.3 - POWER CABLES, PLUGS and CHARGING CABLE WARNINGS	5
1.4 - WALL MOUNTING WARNINGS	5
2 - GENERAL INFORMATION	6
2.1 - INTRODUCTION OF THE PRODUCT COMPONENTS	6
2.2 - DIMENSIONAL DRAWINGS	7
2.2.1 - Without Display Model	7
2.2.2 - With Display Model	7
3 - REQUIRED EQUIPMENT, TOOLS and ACCESSORIES	8
4 - TECHNICAL SPECIFICATION	9
5 - INSTALLING CHARGING STATION	11
5.1 - BOX CONTENTS FOR CHARGING STATION WITH SOCKET AND CABLE	11
5.2 - SUPPLIED INSTALLATION EQUIPMENT and ACCESSORIES	12
5.3 - PRODUCT INSTALLATION STEPS	13
5.3.1 - OPENING THE COVER OF THE CHARGING STATION	13
5.3.2 - WALL MOUNT INSTALLATION	14
5.3.3- SINGLE PHASE CHARGING STATION AC MAINS CONNECTION	17
5.3.4 - THREE PHASE CHARGING STATION AC MAINS CONNECTION.....	19
5.3.5 - ADJUSTING CURRENT LIMITER.....	20
5.3.6 - DIP SWITCH SETTINGS.....	21
5.3.6.1 - DATA CABLE CONNECTION	22
5.3.6.2 - EXTERNAL ENABLE INPUT FUNCTIONALITY	23
5.3.6.3 - LOCKED CABLE FUNCTION (Model With Socket).....	25
5.3.6.4 - POWER OPTIMIZER (REQUIRES OPTIONAL ACCESSORIES).....	26
5.3.6.4.1 - Power Optimizer With External MID Meter.....	27
5.3.7 - MODE SELECTION SWITCH SETTINGS	29
5.3.8 - LOAD SHEDDING.....	30
5.3.9 - MONITORING OF WELDED RELAY CONTACTS FAILURE	31
5.3.10 - FACTORY RESET	32
5.3.11 - RESETTING LOCAL RFID CARD LIST AND REGISTERING NEW MASTER RFID CARD IN STANDALONE USAGE MODE.....	32
5.3.12 - SETTING ETHERNET PORT OF CHARGER TO STATIC IP IN STANDALONE USAGE MODE.....	33
5.3.13 - WEB CONFIGURATION INTERFACE ENABLE / DISABLE	33
5.4 - OCPP CONNECTION	34
5.4.1 - CONNECT OCPP OVER ETHERNET.....	34

5.5 - COMMISSIONING	36
5.5.1 - CONNECT PC TO THE SAME NETWORK WITH SMART BOARD	36
5.5.2 - OPENING WEB CONFIGURATION INTERFACE WITH BROWSER	37
5.5.3 - OPENING WEB CONFIGURATION INTERFACE VIA WIFI HOTSPOT.....	38
5.6 - WEB CONFIGURATION INTERFACE.....	39
5.6.1 - MAIN PAGE	39
5.6.2 - CHANGE GENERAL SETTINGS OF THE DEVICE	40
5.6.2.1 - Display Language:	40
5.6.2.2 - Display Backlight Settings:	40
5.6.2.3 - Led Dimming Settings:	41
5.6.2.4 - Standby LED Behaviour:	41
5.6.2.5 - Display Theme:	42
5.6.2.6 - Display Service Contact Info:	42
5.6.2.7 - Logo Settings:	43
5.6.2.8 - Display QR Code:	43
5.6.3 - INSTALLATION SETTINGS	44
5.6.3.1 - Earthing system:	44
5.6.3.2 - Current Limiter Settings:	44
5.6.3.3 - Unbalanced Load Detection:	45
5.6.3.4 - External Enabled Input:	45
5.6.3.5 - Lockable Cable:.....	46
5.6.3.6 - Charging Mode Selection and Power Optimizer Configuration:	46
5.6.3.7 - Location	47
5.6.3.8 - Load Shedding Minimum Current	47
5.6.4 - CHANGE OCPP SETTINGS OF THE DEVICE	48
5.6.5 - CHANGE NETWORK INTERFACES SETTINGS OF THE DEVICE.....	49
5.6.6 - CHANGE STANDALONE MODE SETTINGS OF THE DEVICE.....	51
5.6.7 - LOCAL LOAD MANAGEMENT OF THE DEVICE.....	52
5.6.7.1 - Modbus TCP/IP Protocol Parameters.....	52
5.6.7.2 - Static Management	52
5.6.7.3 - Dynamic Management	52
5.6.7.4 - Star Topology	53
5.6.7.4.1 - Static Supply Star Topology:	53
5.6.7.5 - Charging Station Role.....	54
5.6.7.5.1 - Configuration of Slave Charging Stations.....	54
5.6.7.5.2 - Configuration of Master Charging Station	56
5.6.7.6 - Equally shared	59
5.6.7.7 - FiFo (First in - First Out).....	59
5.6.7.8 - Combined Load Management	60
5.6.8 - MAKING SYSTEM MAINTANENCE OF THE DEVICE	63
5.6.9 - FIRMWARE UPDATE SCREEN FLOW (With Display Models)	64

1 - SAFETY INFORMATION



CAUTION
RISK OF ELECTRIC SHOCK



CAUTION: ELECTRIC VEHICLE CHARGER DEVICE SHALL BE MOUNTED BY A LICENSED OR AN EXPERIENCED ELECTRICIAN AS PER ANY REGIONAL OR NATIONAL ELECTRIC REGULATIONS AND STANDARDS IN EFFECT.



CAUTION

AC mains connection and load planning of the electric vehicle charging device shall be reviewed and approved by authorities as specified by the regional or national electric regulations and standards in effect.



For multiple electric vehicle charger installations the load plan shall be established accordingly. The manufacturer shall not be held liable directly or indirectly for any reason whatsoever in the event of damages and risks that are borne of errors due to AC mains supply connection or load planning.

IMPORTANT - Please read these instructions fully before installing or operating

1.1 - SAFETY WARNINGS

- Keep this manual in a safe place. These safety and operating instructions must be kept in a safe place for future reference.
- Check that the voltage marked on the rating label and do not use charging station without appropriate mains voltage.
- Do not continue to operate the unit if you are in any doubt about it working normally, or if it is damaged in any way - switch off the mains supply circuit breakers (MCB and RCCB). Consult your local dealer.
- The ambient temperature range should be between -35°C and $+55^{\circ}\text{C}$ without direct sunlight and at a relative humidity of between 5 % and 95 %. Use the charging station only within these specified operating condition.
- The device location should be selected to avoid excessive heating of the charging station. High operating temperature caused by direct sunlight or heating sources, may cause reduction of charging current or temporary interruption of charging process.
- The charging station is intended for outdoor and indoor use. It can also be used in public places.
- To reduce the risk of fire, electric shock or product damage, do not expose this unit to severe rain, snow, electrical storm or other severe weathers. Moreover, the charging station shall not be exposed to spilled or splashed liquids.
- Do not touch end terminals, electric vehicle connector and other hazardous live parts of the charging station with sharp metallic objects.
- Avoid exposure to heat sources and place the unit away from flammable, explosive, harsh, or combustible materials, chemicals, or vapors.
- Risk of Explosion. This equipment has internal arcing or sparking parts which should not be exposed to flammable vapors. It should not be located in a recessed area or below floor level.
- This device is intended only for charging vehicles not requiring ventilation during charging.
- To prevent risk of explosion and electric shock, ensure that the specified Circuit Breaker and RCD are connected to building grid.
- The lowest part of the socket-outlet shall be located at a height between 0,5 m and 1,5 m above ground level.
- Adaptors or conversion adapters are not allowed to be used. Cable extension sets are not allowed to be used.



WARNING: Never let people (including children) with reduced physical, sensory or mental capabilities or lack of experience and/or knowledge use electrical devices unsupervised.



CAUTION: This vehicle charger unit is intended only for charging electric vehicles not requiring ventilation during charging.

1.2 - GROUND CONNECTION WARNINGS

- Charging station must be connected to a centrally grounded system. The ground conductor entering the charging station must be connected to the equipment grounding lug inside the charger. This should be run with circuit conductors and connected to the equipment grounding bar or lead on the charging station. Connections to the charging station are the responsibility of the installer and purchaser.
- To reduce the risk of electrical shock, connect only to properly grounded outlets.
- **WARNING:** Make sure that during installing and using, the charging station is constantly and properly grounded.

1.3 - POWER CABLES, PLUGS and CHARGING CABLE WARNINGS

- Be sure that charging cable is Type 2 socket compatible on charging station side.
- A damaged charging cable can cause fire or give you an electric shock. Do not use this product if the flexible Charging cable or vehicle cable is frayed, has broken insulation, or shows any other signs of damage.
- Ensure that the charge cable is well positioned thus; it will not be stepped on, tripped over, or subjected to damage or stress.
- Do not forcefully pull the charge cable or damage it with sharp objects.
- Never touch the power cable/plug or vehicle cable with wet hands as this could cause a short circuit or electric shock.
- To avoid a risk of fire or electric shock, do not use this device with an extension cable. If the mains cable or vehicle cable is damaged it must be replaced by the manufacturer, its service agent, or similarly qualified persons in order to avoid a hazard.

1.4 - WALL MOUNTING WARNINGS

- Read the instructions before mounting your charging station on the wall.
- Do not install the charging station on a ceiling or inclined wall.
- Use the specified wall mounting screws and other accessories.
- This unit is rated for indoor or outdoor installation. If this unit is mounted outdoors, the hardware for connecting the conduits to the unit must be rated for outdoor installation and be installed properly to maintain the proper IP rating on the unit.

2 - GENERAL INFORMATION

2.1 - INTRODUCTION OF THE PRODUCT COMPONENTS

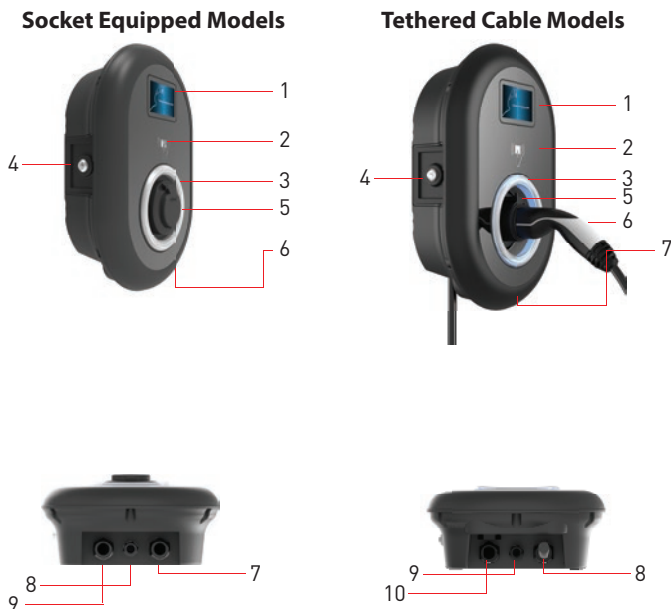

Figure-1

EN Socket Models

1. Information Display (Optional)
2. RFID Card Reader
3. Status indicator LED
4. Access cover for residual current device (Optional)
5. Socket Outlet
6. Product Label
7. Charging station communication cable gland nut
8. Charging station communication cable gland nut
9. Charging station supply inlet gland nut

EN Tethered Cable Models

1. Information Display (Optional)
2. RFID Card Reader
3. Status indicator LED
4. Access cover for residual current device (Optional)
5. Dummy Socket
6. Charging Plug
7. Product Label
8. Charging cable
9. Charging station communication cable gland nut
10. Charging station supply inlet gland nut

2.2 - DIMENSIONAL DRAWINGS

2.2.1 - Without Display Model

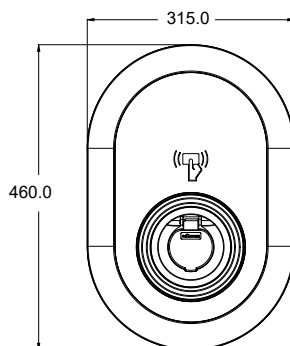

Figure-2

2.2.2 - With Display Model

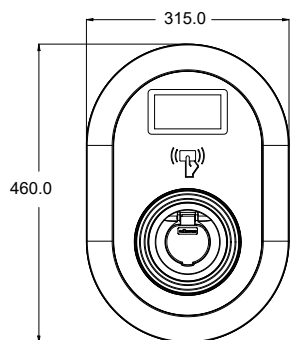

Figure-3

3 - REQUIRED EQUIPMENT, TOOLS AND ACCESSORIES











		
Drill Bit 8mm	Impact Drill	PC
		
Volt Indicator	Torx T25 Security Screwdriver	Water Level
		
Flathead Screwdriver (Tip width 2.00-2.5 mm)	Pointed Spudger	Right Angle Screwdriver Adapter / Torx T20 Security Bit
		
RJ45 Crimping Tool	Cat5e or cat6 ethernet cable	

Table-1

4 - TECHNICAL SPECIFICATION

This product is compliant to IEC61851-1 (Ed3.0) standard for Mode 3 use.

Model	Defenzo Wallbox AC22 Smart	
IEC Protection class	Class - I	
Vehicle Interface	Socket Model	Socket TYPE 2 (IEC 62196)
	Cable Model	Cable with TYPE 2 (IEC 62196) Female Socket
Voltage and Current Rates	400 V AC 50/60 Hz - 3-phase 32 A	
AC Maximum Charge Output	22 kW	
Idle Power Consumption	3.5 W	
Built-in Residual Current Sensing module	6 mA	
Required Circuit Breaker on AC Mains	4P - 40 A MCB Type-C	
Required Leakage Current Relay on AC Mains (for products which are not equipped with RCCB Type A)	4P - 40 A - 30 mA RCCB Type-A	
Required AC Mains Cable	5x 6 mm ² (< 50 m) External Dimensions: Ø 18–25 mm	

CONNECTIVITY

Ethernet	10/100 Mbps Ethernet (Standard with Smart Options)
Wi-Fi (Optional)	Wi-Fi 802.11 a/b/g/n/ac
Bluetooth (Optional)	BT 4.2/BT 5.0

OTHER FEATURES (Connected Models)

Diagnostics	WebconfigUI
Software Update	WebconfigUI update

AUTHORIZATION

RFID	ISO-14443A/B and ISO-15693
-------------	----------------------------

MECHANICAL SPECIFICATIONS

Material	Plastic
Product size	315 mm (Width) x 460 mm (Height) x 135 mm (Depth)
Dimensions (with package)	405 mm (Width) x 530 mm (Height) x 325 mm (Depth)
Product weight	5 kg for socket equipped model, 6.8 kg for tethered cable model (3 Phases)
Weight with package	7,1 kg for socket equipped model, 8.9 kg for tethered cable model (3 Phases)
AC Mains Cable Dimensions	For three-phase models Ø 18-25 mm
Cable Inlets	AC Mains / Ethernet / Modbus

ENVIRONMENTAL TECHNICAL SPECIFICATIONS

Protection Class	Ingress Protection Impact Protection	IP54 IK10 (Optional display have IK08 protection)
Usage Conditions	Temperature Humidity Altitude	-35 °C to 55 °C (without direct sunlight) 5% - 95% (relative humidity, non-condensing) 0 - 4,000 m

5 - INSTALLING CHARGING STATION

5.1 - BOX CONTENTS FOR CHARGING STATION WITH SOCKET AND CABLE

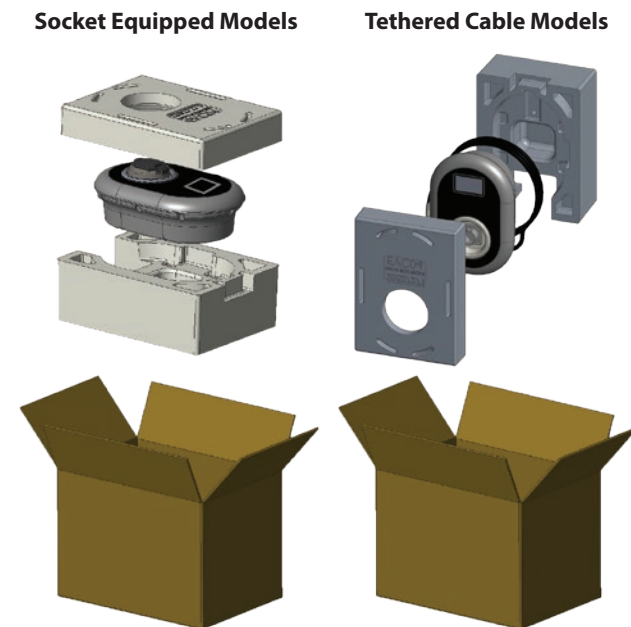

Figure-4

5.2 - SUPPLIED INSTALLATION EQUIPMENT and ACCESSORIES













Accessory/Material Name	Use For	Quantity	Picture
Dowels (M8x50 Plastic Dowels)	Mounting charging station to the wall	4	
Torx T25 Security Screw (M6x75)	Mounting charging station to the wall	4	
Gasket for screw 6x75	IP for screws which are used for mounting charging station to the Wall.	4	
Torx T20 Security L-Wrench	IP for screws which are used for mounting charging station to the Wall.	1	
Wrench	Disassembling and fastening the cable glands	1	
Mounting Template	Mounting the charging station to the wall	1	
O-Ring	Mounting the charging station to the pole	3	
Screw M6X20	Mounting the charging station to the pole	3	
Screw M6X30	Mounting and providing earth continuity for the charger, that mounts to metal surface. This screw should be mounted to the right-down hole of charging station to the Wall. Below this screw, there should be rubber under it to fix the ground cable.	1	
IP Rubber	Fixing the ground cable with the screw M6x30. This rubber should be placed to right-down Wall mount hole of charging station, under the ground cable and screw M6x30	1	
User RFID Card	Start&Stop Charging	1	
Master RFID Card	Adding&Removing the User RFID Cards to Local RFID List	1	
Instruction Book	User Manual	1 Set	



Table-2



5.3 - PRODUCT INSTALLATION STEPS

CAUTION!

- Ensure that ground resistance of the installation less than 100ohms.
- Prior to mounting your charging station on the wall, read these instructions.
- Do not mount your charging station to the ceiling or an inclined wall.
- Use the wall mounting screws and other accessories specified.
- This charging station is classified as indoor and outdoor installation compatible. If the device is installed outside the building, the hardware that will be used to connect the cables to the charger shall be compatible with outdoor use and the charging station shall be mounted preserving the IP rate of the charger.

5.3.1 - OPENING THE COVER OF THE CHARGING STATION

	CAUTION RISK OF ELECTRIC SHOCK	
Please power off the charging station mains supply 		

	
1	2
<ol style="list-style-type: none">1. Remove the cover screws with Torx T20 security L-Wrench or Right Angle Screwdriver Adapter using Torx T20 Security Bit.2. Open the cover.	

5.3.2 - WALL MOUNT INSTALLATION

Wall mount installation is common for all charging station models.

1. Open the product front cover by following the instruction.
2. Place the charging station to the Wall by using the mounting template which is given in accessory bag and mark the drill bit holes with a pencil.
3. Drill the wall on the marked points using the impact drill (8mm drill bit).
4. Place the dowels into the holes.
5. Tighten the security screws (6x75) of the product using Torx T25 Security Screwdriver.
6. Insert the AC mains cable into the charging station from the left cable gland which below the station. Follow the AC Mains Connection instructions on the next pages, depending on the model of the charger. (Single/Three Phase)
7. In case you mount the charging station to conductive metal surface such as metal pole etc..., you can make ground connection via "right-bottom" screw using ground extension cable as shown in figure-6. To ensure the grounding, you need to change the grounding cable position from "a" to "b" as shown in figure-6. Follow the instructions below:
 - I. Insert the plastic support (IP rubber which is given inside accessory pack of the unit), to the fixing hole (Position "b")
 - II. Fix the grounding cable using M6x30 screw, which is inside the artwork pack and this screw is also used to assemble to product to the conductive metal surface.
8. Tighten the cable glands as shown in the figure. Before closing the cover of the charging station, follow the instructions in next sections if any function related to these sections are used.
9. To close the cover of the charging station, tighten the cover screws which you were removed with Torx T20 Security L-Wrench or Right Angle Screwdriver Adapter using Torx T20 Security Bit.
10. Mounting the charging station on the wall is finished.

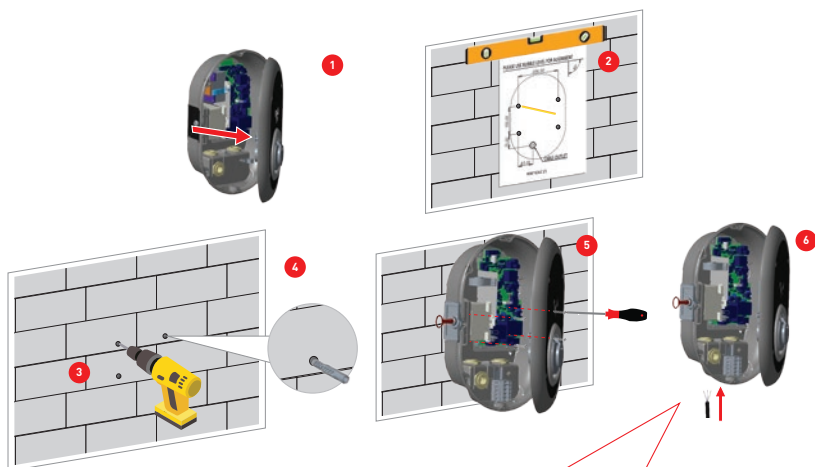

Before closing the cover of the charging station, check next instructions if any function related to these sections are used.

Figure-5

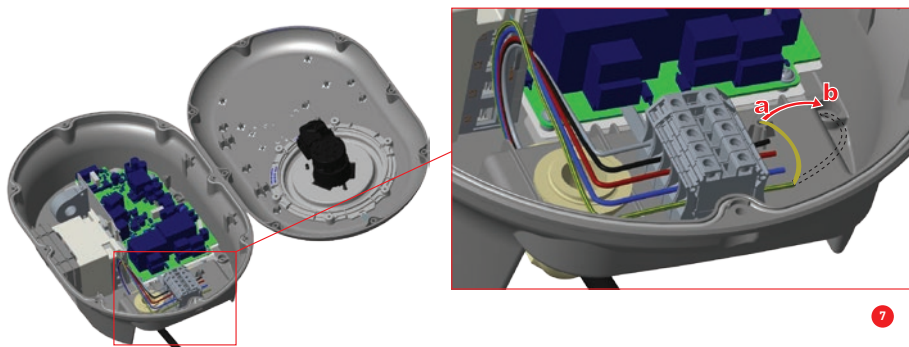

Figure-6

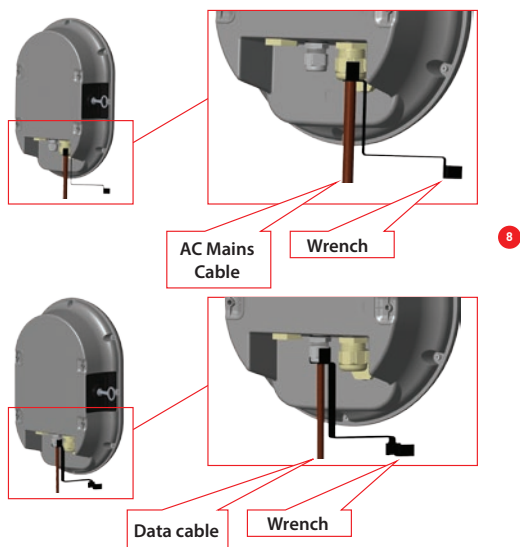

Figure-7

Before next step (7), Please check the instructions for Single Phase or Three Phase cable connections.

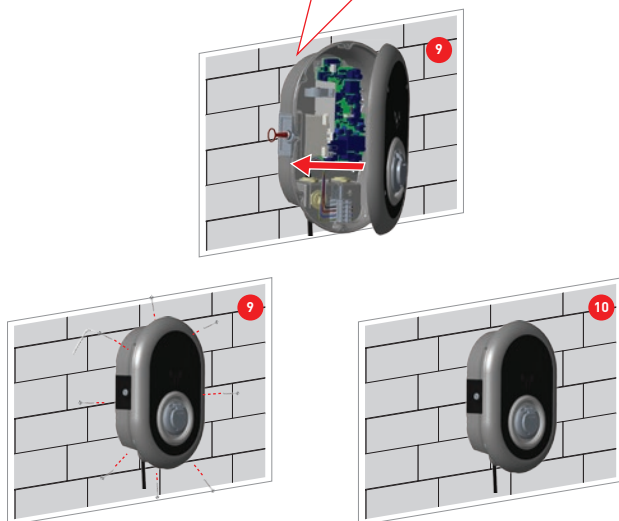

Figure-8

5.3.3- SINGLE PHASE CHARGING STATION AC MAINS CONNECTION

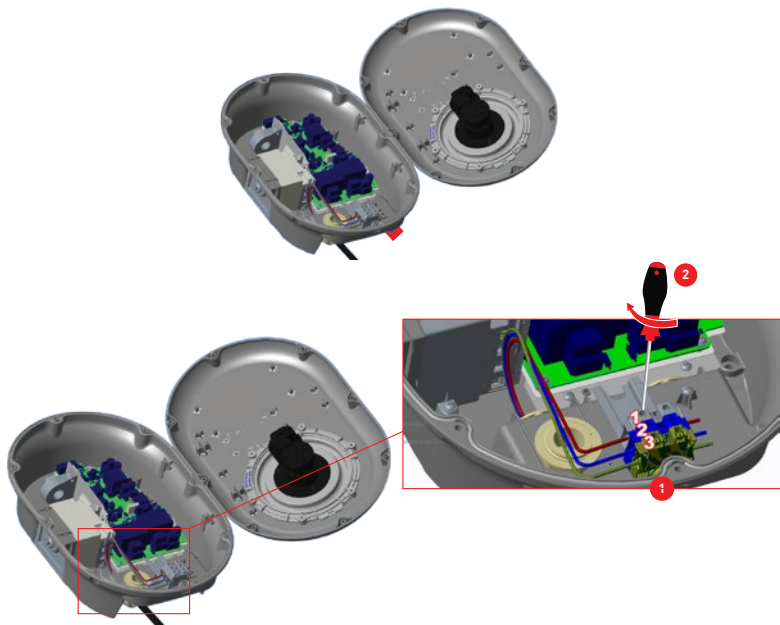

Figure-9

1. Insert the cables to the terminal block as shown in the image. Check the table-3 below to match Electric Terminal number with AC Cable Color.
2. Tighten the screws on the terminal block as shown in the image with the tightening torque of 2.5Nm.

Electric Terminal	AC Cable Color
1	AC L1 (Brown)
2	AC Neutral (Blue)
3	Earth (Green-Yellow)

Table-3

For single phase **IT Grid** installation, wiring diagram which is shown below should be used. Also grounding type should be set to "IT Grid" from the "Installation settings" menu in web user interface.

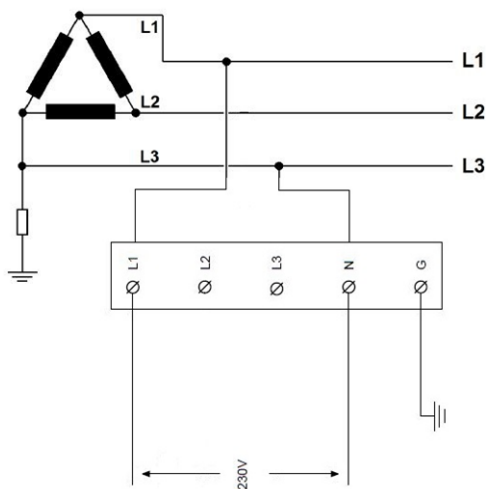

5.3.4 - THREE PHASE CHARGING STATION AC MAINS CONNECTION

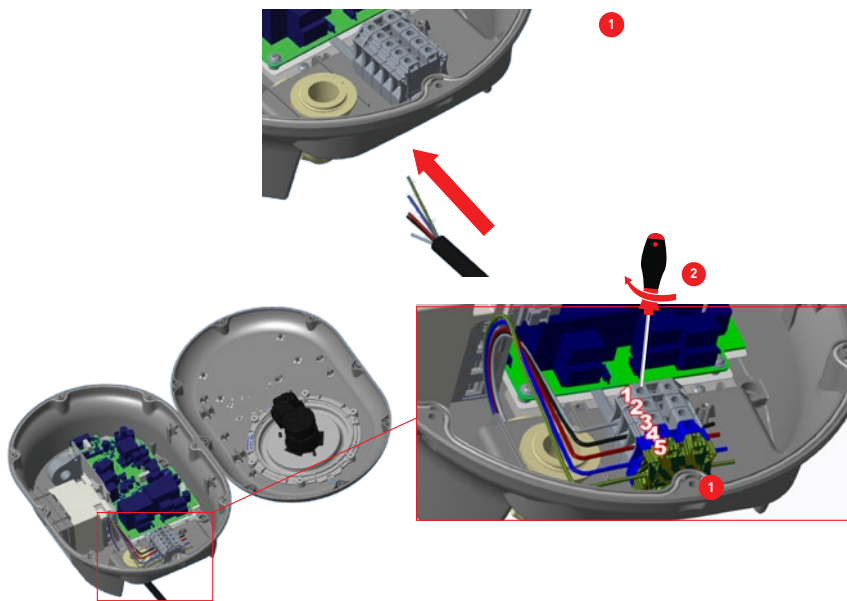

Figure-10

1. Insert the cables to the terminal block as shown in the image. Check the table-4 below to match Electric Terminal number with AC Cable Color.
2. Tighten the screws on the terminal block as shown in the image with the tightening torque of 2.5Nm.

Electric Terminal	AC Cable Color
1	AC L3 (Grey)
2	AC L2 (Black)
3	AC L1 (Brown)
4	AC Neutral (Blue)
5	Earth (Green-Yellow)

Table-4

If the three phase charging station is requested to be installed as single phase, phase cable connection should be done to L1 terminal as shown in figure-9.

5.3.5 - ADJUSTING CURRENT LIMITER

The charging station has current limiter (rotary switch) on the mainboard which is shown in figure-11. This switch is used for adjusting the current and power of charging station. The arrow in the middle of the rotary switch must be adjusted gently by rotating with a flathead screwdriver to the position of the required current rate. The details of the current rates are described in table- 5.

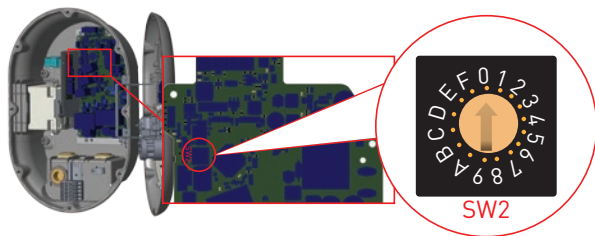

Figure-11

Current Limiter Position	Current Limit Value			
	Phase	22 kW	11kW	7.4kW
0	1- Phase	10 A	10 A	10 A
1		13 A	13 A	13 A
2		16 A	16 A	16 A
3		20 A		20 A
4		25 A		25 A
5		30 A		30 A
6		32 A		32 A
7				
8	3- Phase	10 A	10 A	
9		13 A	13 A	
A		16 A	16 A	
B		20 A		
C		25 A		
D		30 A		
E		32 A		
F				

Table-5

Required Circuit Braker on AC Mains	
<u>EV Charging Station Current Limiter Setting</u>	<u>C-Curve MCB</u>
10 A	13 A
13 A	16 A
16 A	20 A
20 A	25 A
25 A	32 A
30 A	40 A
32 A	40 A

Table-6

5.3.6 - DIP SWITCH SETTINGS

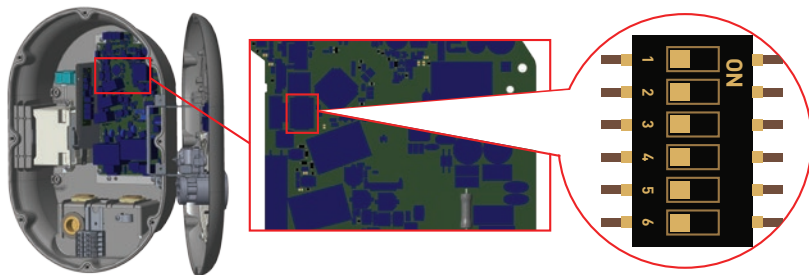

Figure-12

Brief descriptions of the DIP switch pin settings can be found in below table.

Pin Number	Description
Pin-1	Reserved
Pin-2	External Enable Input Functionality
Pin-3	Locked Cable Function (only for socket models)
Pin-4-5-6	Power Optimizer (Requires Optional Accessories)

Table-7

5.3.6.1 - DATA CABLE CONNECTION

1. Remove rubber cork from cable gland.
2. Insert cable through the cable holes.
3. Insert the cable through the RCCB housing holes.
4. Finally, to connect the wires on mainboard, check next sections depending on the functions to be used.

NOTE: Below data connection cables can be inserted through the cable holes;

- a. External enable input cable
- b. Power optimizer measurement cable
- c. Load shedding triggering signal cable
- d. Shunt trip module control signal cable for welded relay contact failure

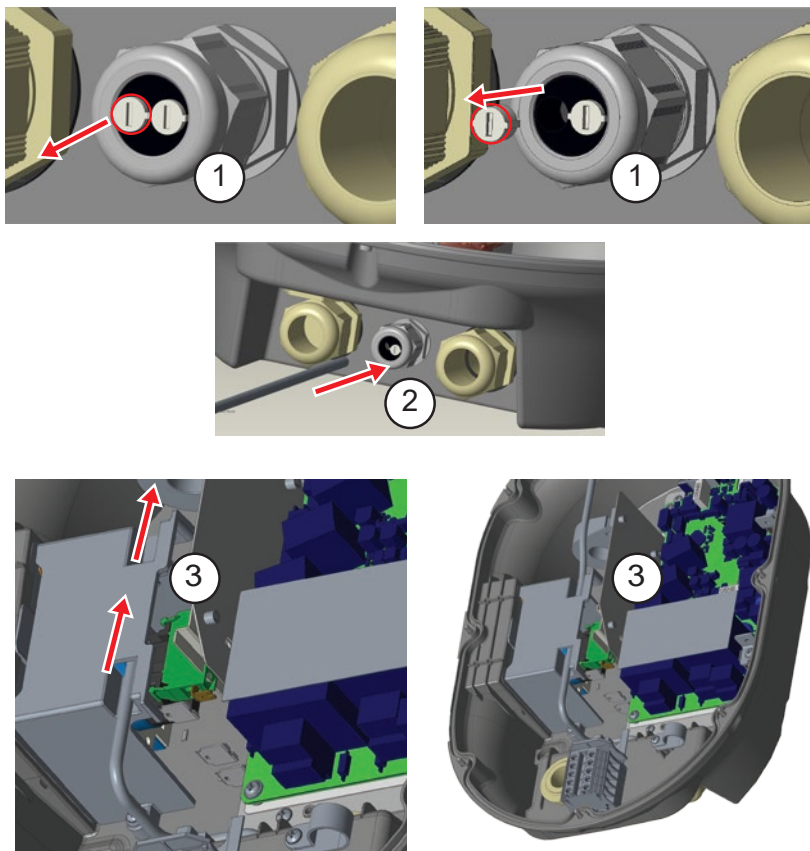

Figure-13

5.3.6.2 - EXTERNAL ENABLE INPUT FUNCTIONALITY

Your charging station has external potential free enable / disable functionality which can be used for integration of your charging station to an carpark automation systems, energy supplier ripple control devices, time switches, photovoltaic inverters, auxiliary load control switches, external key lock switches etc. DIP switch position 2 is used for enabling and disabling this functionality.

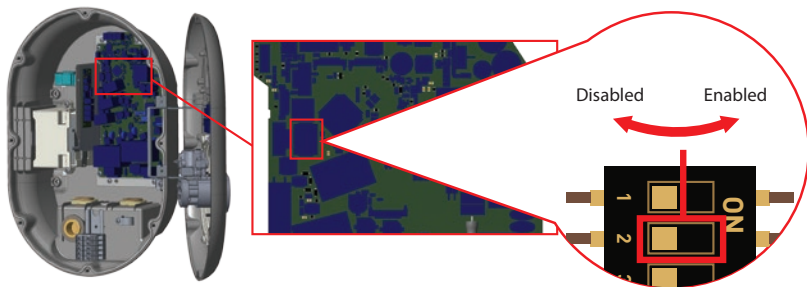

Figure-14

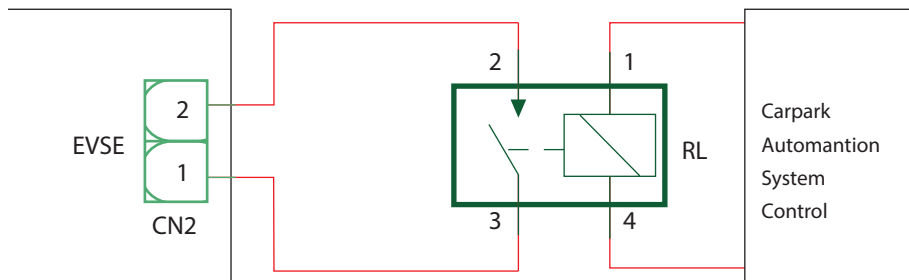

Figure-15

If the external relay (RL) is in non-conducting (open), the charging station will not be able to charge the electric vehicle.

You can connect potential free input signals as shown in above circuitry (see figure-15).

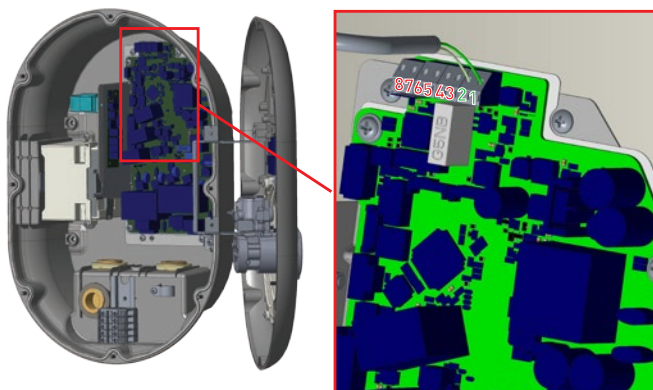

Figure-16

Cable Terminal	Cable Color
1 (CN2-1)	Green
2 (CN2-2)	Green + White Green

Table-8

5.3.6.3 - LOCKED CABLE FUNCTION (Model With Socket)

This charging station has functionality for fixing the charging cable of the user, to the charging socket of the unit. The cable becomes locked and socket model charging station behaves as a cabled model. For this functionality, the steps in table-9 can be followed.





<p>1. Turn off the power of your charging station.</p> 	<p>2. Open the product cover as described in the installation manual.</p> 
<p>3. To enable locked cable function, toggle DIP switch pin 3 to ON position using pointed spudger or a plastic pointed tool. The DIP switch location is as shown in below figure.</p> 	<p>4. Close the product cover as described in the installation manual.</p> 
<p>5. Open the front cover of the socket outlet and plug the charging cable to the socket outlet.</p>  	<p>6. Turn on the power to your charging station. The cable becomes locked and the charging station starts behaving as a cable model.</p> 

Table-9

5.3.6.4 - POWER OPTIMIZER (REQUIRES OPTIONAL ACCESSORIES)

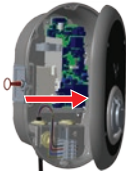
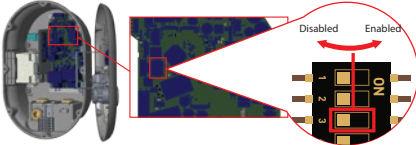
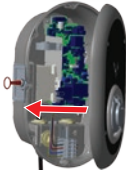
The EV charger has Power Optimizer with External MID meter to make single load balancing.

To adjust the power optimizer, the slide switch (mode selection switch - SW3) on the control board should be in position to 1 or 2 as shown in figure-17. If the switch is set to position 3, power optimizer does not work.

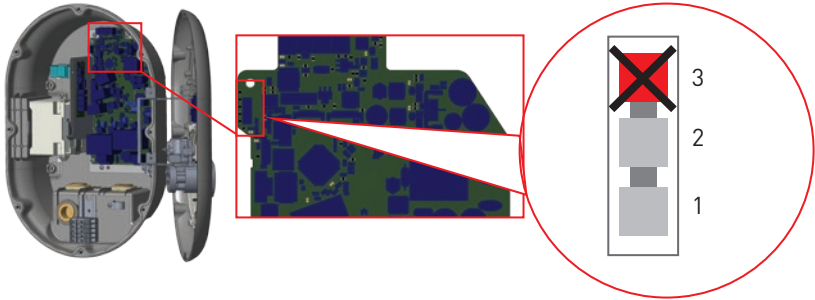

Figure-17

This feature is provided with an optional metering accessories which are sold separately. In power optimizer mode, the total current drawn from the main switch of the house by charging station and other household appliances is measured with current sensor integrated to the main power line. Current limit of the main power line of the system is set through the DIP switches inside the charging station. According to the limit set by the user, charging station adjusts its output charging current dynamically according to the measurement of main power line.

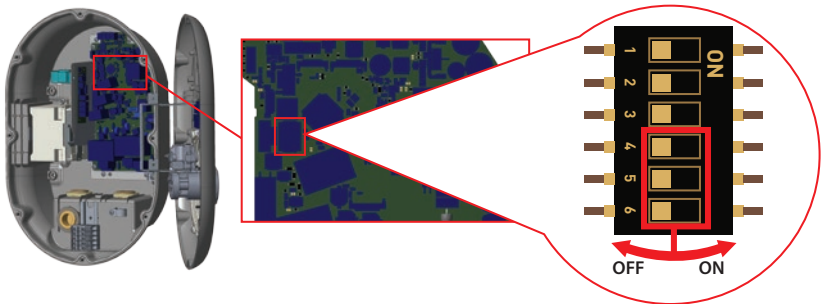

Figure-18

Last 3 DIP switch pins (4,5,6) shown in figure-18 corresponds to binary digits of the maximum current value as shown in the table-10. When 4, 5, 6 pins are in OFF position, power optimizer functionality is disabled.

DIP Switch Positions			Current Limit Value
4	5	6	
OFF	OFF	OFF	Power Optimizer Disabled
OFF	OFF	ON	16
OFF	ON	OFF	20
OFF	ON	ON	25
ON	OFF	OFF	32
ON	OFF	ON	40
ON	ON	OFF	63
ON	ON	ON	80

Table-10

5.3.6.4.1 - Power Optimizer With External MID Meter

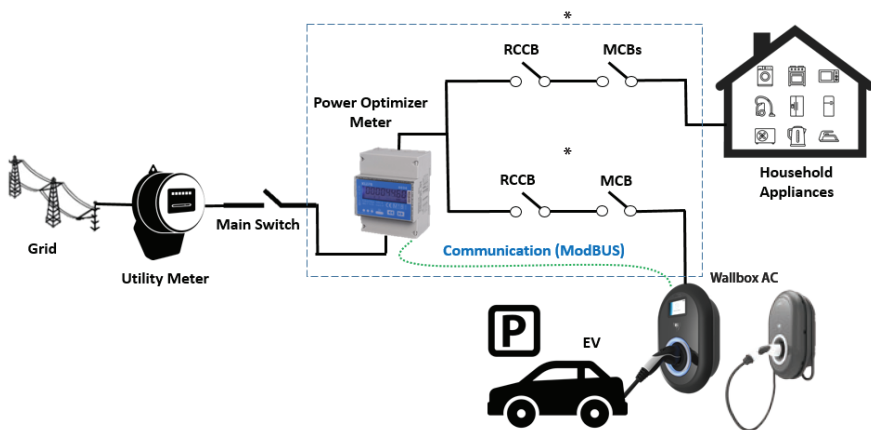

Figure-19

*This figures valid for variants which do not have integrated RCCB. If the charging station has integrated RCCB, there is no need to add additional RCCB in power line.

Power Optimizer Meter should be placed just after the main switch of the house as shown in the figure-19.

Power Optimizer Meter wiring connections can be made according to the information below.

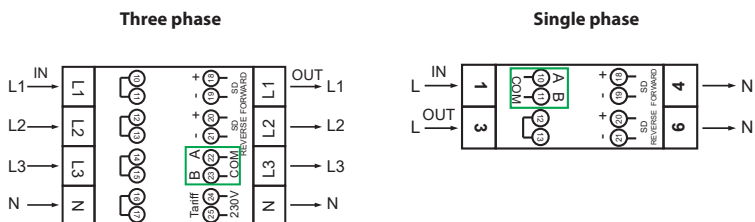

Figure-20

- 22-23: A-B (COM) Modbus connection over RS485 for three phase charging station models.
 - 10-11: A-B (COM) Modbus connection over RS485 for single phase charging station models.
- Related board wiring of Power Optimizer connections can be made as shown below:

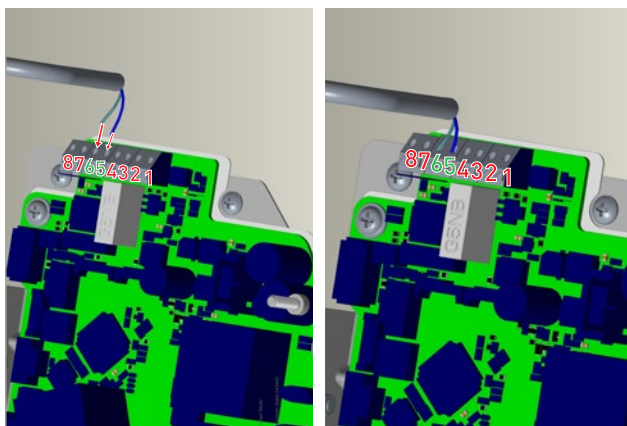

Figure-21

Cable Terminal	Cable Color	Description
6 (CN20-2)	White Blue	A (COM)
5 (CN20-1)	Blue	B (COM)

Table-11

5.3.7 - MODE SELECTION SWITCH SETTINGS

This charging station has 3 operation modes. For standart charging the mode selection should be in position 1.

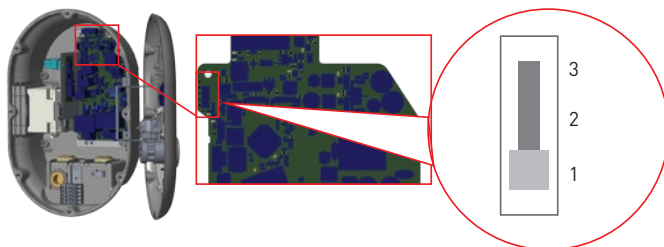

Figure-22

1. **Operation Mode 1 (Standard Charging):** This mode is factory default configuration. When this mode is selected, charging station does not support peak/off peak time or TIC dynamic charging scenarios.
2. **Operation Mode 2 (Postponed Charging):** For this mode, slide switch should be positioned as 2. When this mode is selected, charging station supports "C1-C2 Peak/Off Peak Time" signaling input and reacts accordingly for peak/off peak time charging.
3. **Operation Mode 3 (TIC Dynamic Charging):** When this mode is selected, charging station supports receiving TIC (Tele Information Client) I1-I2 signal and reacts accordingly for peak/off peak time charging and regulates its charging power for dynamic load management according to the information sent by the meter via TIC signal.

5.3.8 - LOAD SHEDDING

This charging station supports load shedding functionality which provides immediate charging current reduction in case of limited supply. Load shedding functionality can be used in any mode including Standalone and OCPP connected modes. Load shedding triggering signal is a dry contact signal which must be provided externally and connected to the terminals 3 and 4 on the power board as shown in figure-23.

When load shedding is activated by closing the contacts with an external device (Eg. ripple control receivers etc.) charging current reduces down to 8A. When load shedding is deactivated by opening the contacts charging continues with maximum available current. In normal use case when there is no signal connected to the load shedding input (contacts open between terminal 3 and 4) charging station supplies maximum available current.

You can connect dry contact (potential free) load shedding signal as shown in below. See figure-23, table-12 and table-13.

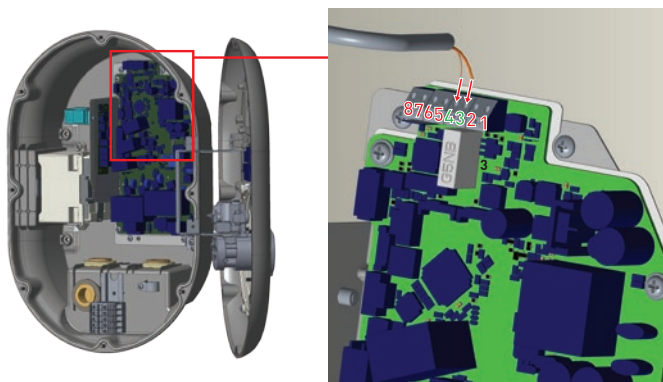

Figure-23

Cable Terminal	Input
3	Load Shedding Input +
4	Load shedding Input -

Table-12

Load Shedding Input State	Behaviour
Opened Contact	Charge with max. available current
Closed Contact	Charge with 8A

Table-13

5.3.9 - MONITORING OF WELDED RELAY CONTACTS FAILURE

According to IEC 61851-1 and EV/ZE Ready requirements, Charging Station has welded contactor sensing function and in case of welded contact occurs, shunt trip 230V signal is provided from the main board. To detect welded contact failure for the relays, CN33 connector output terminals must be used.

In case of a welded contact for the relays CN33 connector output will be 230V AC. The output which has 230V AC should be connected to a shunt trip for RCCB triggering as shown in figure-24. The cabling should be done as shown in figure-25.

Connector (CN33) terminals must be connected to a shunt trip module. Shunt Trip module is mechanically coupled to RCCB (or MCB) at the fuse box of the charging station.

The circuitry block diagram that must be used at the fuse box of the charging station is shown below.

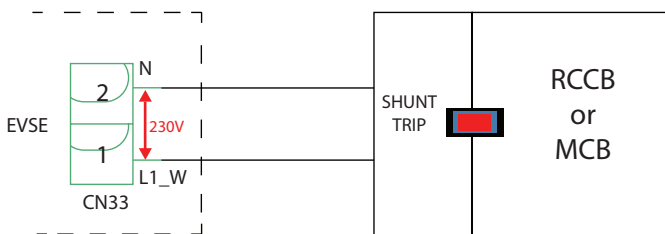

Figure-24

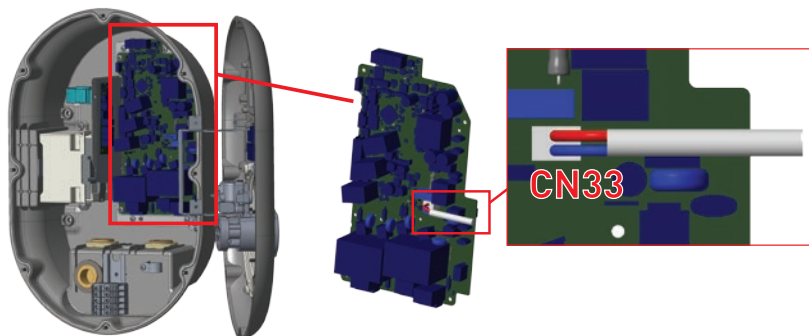

Figure-25

5.3.10 - FACTORY RESET

You must push the button on HMI board shown in figure-26 for factory reset. When you hold the button for 5 seconds user configuration will be reset to factory configuration. (e.g OCPP config, Network Config will be back to factory configuration.)

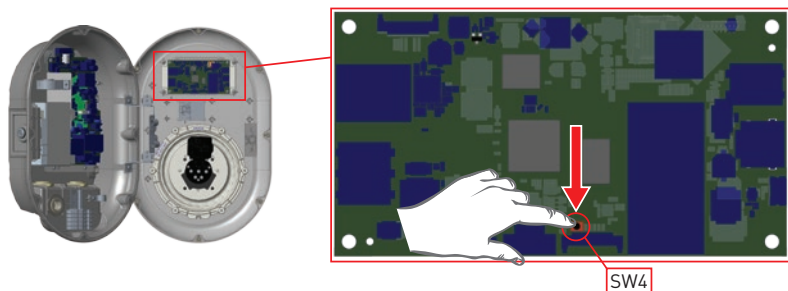

Figure-26

5.3.11 - RESETING LOCAL RFID CARD LIST AND REGISTERING NEW MASTER RFID CARD IN STANDALONE USAGE MODE

If you loose your master RFID card and need to define a new master RFID card, below steps should be followed by your authorised service technician.

- Make sure the charging station is powered-off and open the front cover of your charger which is mentioned in installation guideline.
- Toggle the first position of DIP switch which is on the smart board of the charger shown in figure-27. After that please turn on the charger again.

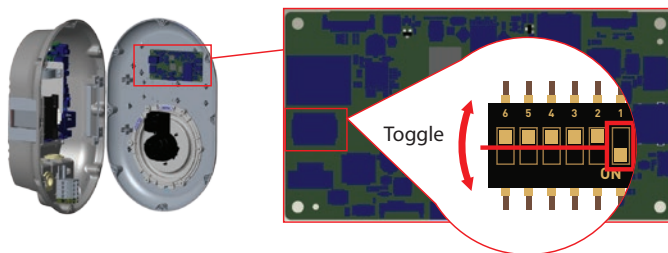

Figure-27

When the charger is powered on again please note that;

- Previously stored master card and user card list, if any exists, are deleted from charging station while entering the configuration mode. In configuration mode, the charger indication LED blinks red.
- If master card had not been registered during 60 seconds then configuration mode expires and charging station behaves as autostart product.
- The first RFID card which is registered within this 60 seconds of duration will be the new master RFID card.

5.3.12 - SETTING ETHERNET PORT OF CHARGER TO STATIC IP IN STANDALONE USAGE MODE

The charging station is preconfigured to DHCP mode in factory. If you need to connect to the charging station's web configuration interface directly using a computer, rather than using a router having DHCP server, steps below should be followed:

- Make sure the charging station is powered-off and open the front cover of your charger which is mentioned in installation guideline.
- Toggle the second position of DIP switch which is on the smart board of the charger shown in figure-28. After that please turn on the charger again.
- Charging station sets the Ethernet port to 192.168.0.10 address statically and subnet mask will be set to 255.255.255.0

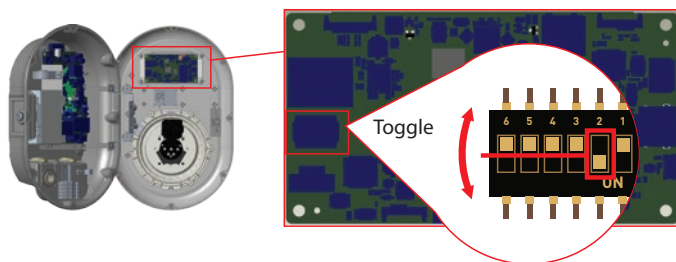

Figure-28

If the charger's LAN interface is needed to be set back to DHCP mode again this can be done from the web configuration interface.

Note: You can also use factory reset function to set the LAN interface back to DHCP mode again but please well note that all other parameters will be set to factory default parameters.

5.3.13 - WEB CONFIGURATION INTERFACE ENABLE / DISABLE

If you need to enable/disable the Web Configuration interface below steps should be followed:

- Make sure the charging station is powered-off and open the front cover of your charger which is mentioned in installation guideline.
- If you want to enable the web configuration interface, third position of DIP switch should be in "OFF" position as shown in figure-29.
- If you want to disable the web configuration interface, third position of DIP switch should be in "ON" position as shown in figure-29.

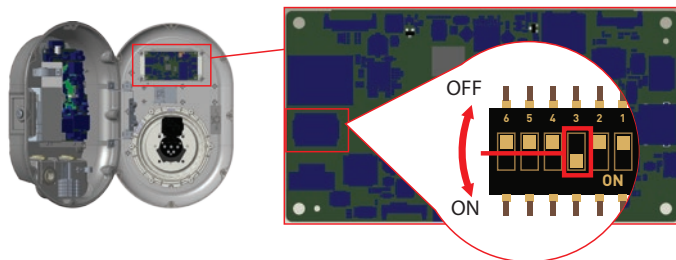

Figure-29

5.4 - OCPP CONNECTION

Make sure the charging station is powered-off.

5.4.1 - CONNECT OCPP OVER ETHERNET

1. Insert cable through the cable gland.

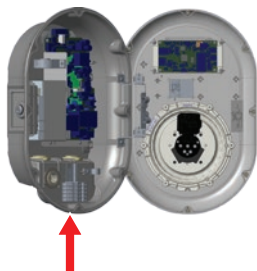

2. Pull the cable through the cable clamps as indicated by arrows in below figure.

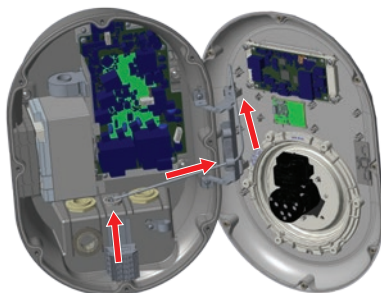

3. Using a Crimping Tool, trim the end of the cable you're terminating, to ensure that the ends of the conducting wires are even.



4. Strip off approximately 1 inch of the cable's jacket, using a modular crimping tool or a UTP cable stripper.



5. Separate the 4 twisted wire pairs from each other, and then unwind each pair, so that you end up with 8 individual wires.



6. Moving from left to right, arrange the wires in a flat, side-by-side ribbon formation, placing them in the following order: white/orange, solid orange, white/green, solid blue, white/blue, solid green, white/brown, solid brown.



7. Carefully insert the flattened, arranged wires into the connector, pushing through until the wire ends emerge from the pins.



8. Check to make sure that the wire ends coming out of the connector's pin side are in the correct order. If you realize that a mistake has been made in wire order after termination, you'll have to cut the connector off and start all over again!



9. Insert the prepared connector/cable assembly into the RJ45 slot in your crimping tool. Firmly squeeze the crimper's handles together until you can't go any further. Release the handles and repeat this step to ensure a proper crimp.



10. If your crimper doesn't automatically trim the wire ends upon termination, carefully cut wire ends to make them as flush with the connector's surface as possible. The closer the wire ends are trimmed, the better your final plug-in connection will be.



11. Termination is complete.

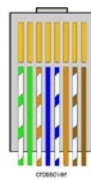
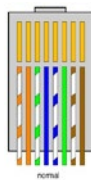

12. Insert the RJ45 connector to the socket as shown in figure below.

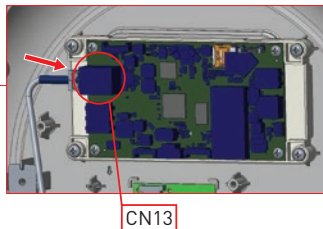
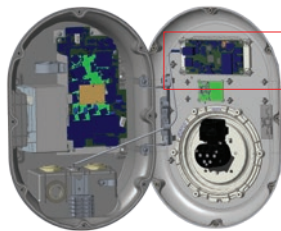

Table-14

5.5 - COMMISSIONING

If you want to connect the charging station's web configuration interface, you have two options;

- a. You can directly connect your PC to the charging station using a patch Ethernet cable. If you follow this option, please make sure that you have properly configured your charging station's LAN interface to static IP by following steps in section "SETTING ETHERNET PORT OF CHARGER TO STATIC IP IN STANDALONE USAGE MODE" and your charging station's web configuration interface is enabled via DIP switch which is mentioned in section "WEB CONFIGURATION INTERFACE ENABLE / DISABLE". By default, web configuration interface is enabled.
- b. You can use a router having DHCP server. In this option, both the charging station and the PC should be connected to the router. Please be sure that you need to check the IP address from the router to be able to make the connection.

For direct PC connection option, you need to connect your PC to the charging station to use functions and make configurations below:

- Login
- Change Password
- Main Page
- General Settings : Display Language, Display Backlight Settings, Led Dimming Settings, Standby Led Behaviour, Display Theme, Display Service Contact Info, Logo Settings, Display QR Code.
- Installation Settings : Earthing System, Current Limiter Settings, Unbalanced Load Detection, External Enable Input, Lockable Cable, Charging Mode Selection and Power Optimizer Configuration-Location -Load Shedding Minimum Current.
- OCPP Settings : OCPP Connection, OCPP Version, Connection Settings, OCPP Configuration Parameters
- Network Interface Settings: Cellular, Ethernet, Wi-Fi, Wi-Fi Hotspot
- Standalone mode settings
- Local Load Management : General Settings
- System Maintenance: Log Files, Firmware Updates, Configuration Backup&Restore, System Reset, Administration Password, Factory Default Configuration

5.5.1 - CONNECT PC TO THE SAME NETWORK WITH SMART BOARD

In order to access web configuration interface, first you need to connect your PC and EV charger to the same ethernet switch or connect EV charger to your PC directly.

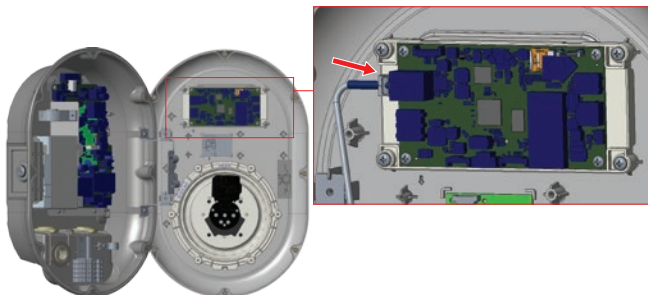

Figure-30

Default IP address of HMI board is 192.168.0.10. For this reason, you need to give static IP to your PC in the same network with HMI board.

You should assign static IP address to your PC in 192.168.0.254 network which means that IP address should be in a range of between 192.168.0.1 and 192.168.0.254.

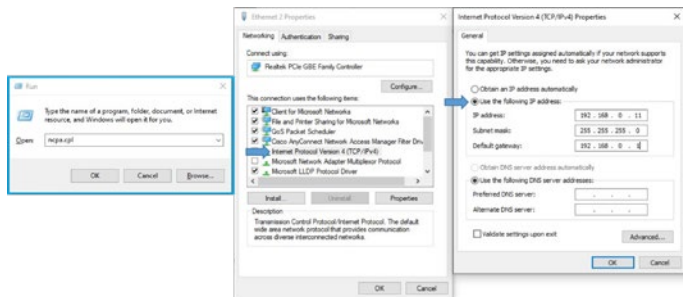

Figure-31

5.5.2 - OPENING WEB CONFIGURATION INTERFACE WITH BROWSER

Open your web browser and type 192.168.0.10 which is IP address of smart board.

You will see login page on your browser;

When you want to enter to the web configuration interface in the first time, you will see the warning as “We recommend you to change your default password from system maintenance menu”.

You can enter the system with:

- Default username = admin
- Default password = admin

You can change password with Change Password Button in login page or Administration Password section in the System Maintenance tab.

Attention: For web configuration interface accessibility problems; Web browsers usually save some information from websites in its cache and cookies. Forcing Refresh or Clearing (depending on your operating system and browser) them fixes certain problems, like loading or formatting issues on web page.

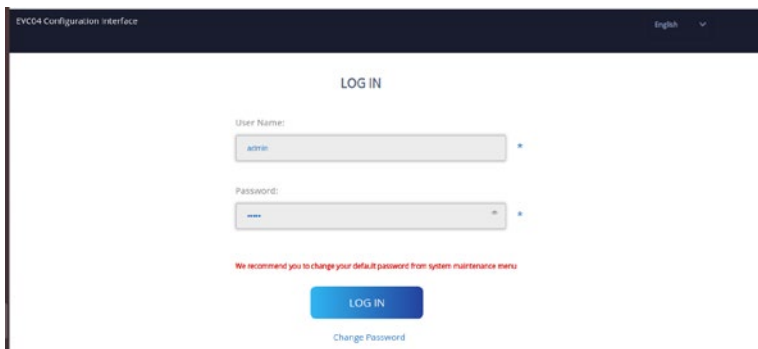

Figure-32

If you click the “Change Password Button” you will be redirected to the Change Password page.

New password must contain at least 1 lowercase letter, 1 uppercase letter, 1 numeric character and minimum 6 characters.

After typing your current password and new password twice, you will be redirected to the login page again to log in with your new password.

All spaces you will see are mandatory in this page.

After submitting this page you will be redirected to login page. Also if you don't want to change the password you can turn back the login page with “Back To Login”. Changing password is important for your security.

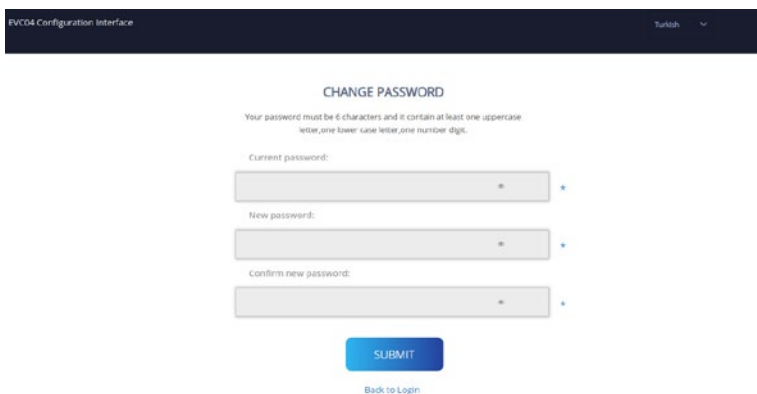

FVCD4 Configuration Interface Turkish

CHANGE PASSWORD

Your password must be 6 characters and it contain at least one uppercase letter, one lower case letter, one number digit.

Current password:

New password:

Confirm new password:

[SUBMIT](#)

[Back to Login](#)

Figure-33

5.5.3 - OPENING WEB CONFIGURATION INTERFACE VIA WIFI HOTSPOT

For this unit, WiFi Hotspot feature is enabled by factory configuration and “turn on during boot” is 10 minutes which means, during every power cycle of the charging station, configuration WiFi hotspot is activated during 10 minutes for configuration of the charging station. During this time, it is possible to connect a device (mobile, tablet or a notebook) with the charging station.

WiFi Hotspot SSID is the unit's serial number. WiFi Hotspot password is unique and should be requested from the customer support. After connecting “Wi-Fi Hotspot” network, user can open WEB browser from computer or mobile device and type 192.168.1.1 which is IP address of the charging station. For android mobile devices, it is needed to configure the browser to download and show desktop site from the menu at the upper right corner in Chrome browser.

For iOS mobile devices, it is needed to configure the browser to download and show desktop site from the menu at the upper right corner and also the the text size should be set to 50% from the AA setting at the upper left corner in Safari browser.

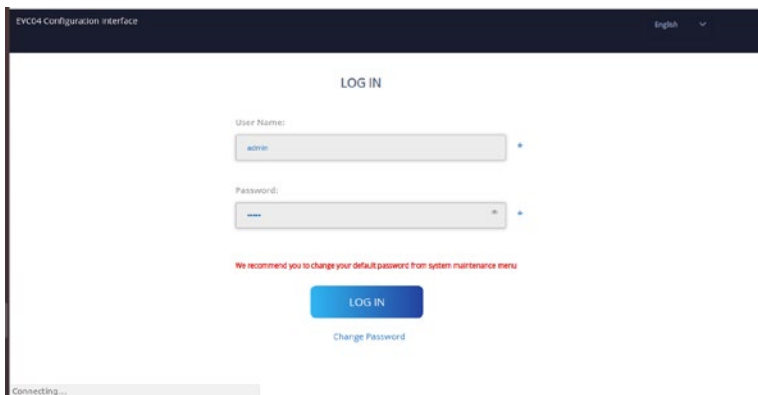

Figure-34

User Name and Password information to enter to web configuration interface are as below.

- User Name: admin
- Password: admin

Note: Maximum 3 users can connect to WEB Configuration Interface via Wi-Fi hotspot. It supports 2.4Ghz.

5.6 - WEB CONFIGURATION INTERFACE

5.6.1 - MAIN PAGE

After you logged in successfully, you are directed to the main page.

Main page shows the general information about the device such as software versions, connection interface and IDs.

You can also change the web configuration interface language and log out of the web configuration interface with the buttons in the upper right corner of the page.

The following languages are available: Turkish, English, German, French, Romanian, Spanish, Italian, Finnish, Norwegian, Swedish, Hebrew, Danish, Czech, Polish, Hungarian, Slovakian, Dutch. The boxes are configured in English by default.

5.6.2 - CHANGE GENERAL SETTINGS OF THE DEVICE

5.6.2.1 - Display Language:

Technician can select display language from the general settings page. Available languages for display language are as shown in figure below for now. After selecting the language, user can save selection by “Save Button”.

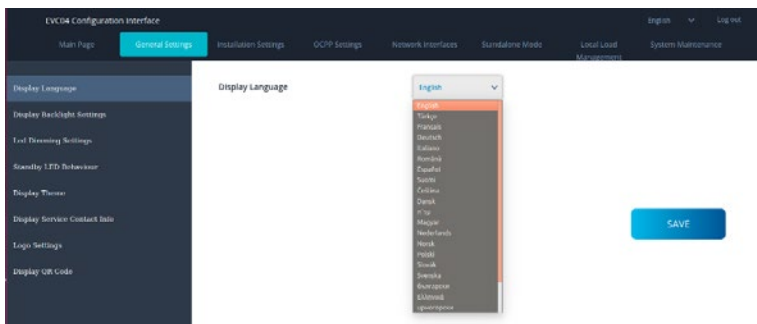

Figure-35

5.6.2.2 - Display Backlight Settings:

Technician can adjust the brightness level of display by selecting the desired option in drop down menu. If technician selects backlight level as “Time Based”, Sunrise and Sunset Time selections are shown and can be configured. “Sunrise Time” defines the transition time of low to high backlight level. Similarly, “Sunset Time” defines the transition time of high to low backlight level. Sunrise and sunset time based configuration is periodic daily setting.

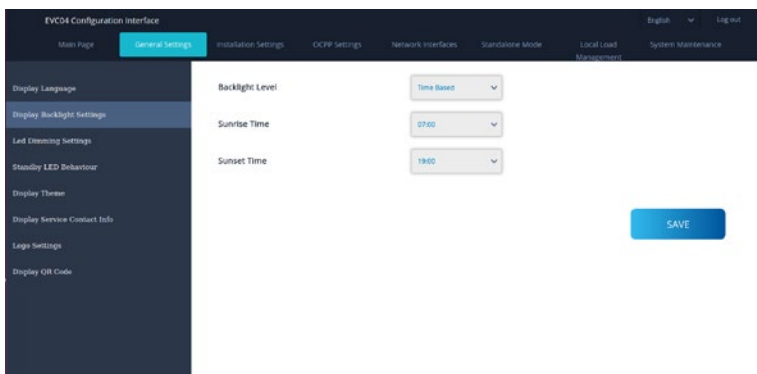

Figure-36

5.6.2.3 - Led Dimming Settings:

Technician can adjust the brightness level of Led ring by selecting the desired option in drop down menu. If technician selects Led dimming level as "Time Based", Sunrise and Sunset Time selections are shown and can be configured. "Sunrise Time" defines the transition time of low to high backlight level. Similarly, "Sunset Time" defines the transition time of high to low backlight level. Sunrise and sunset time based configuration is periodic daily setting.

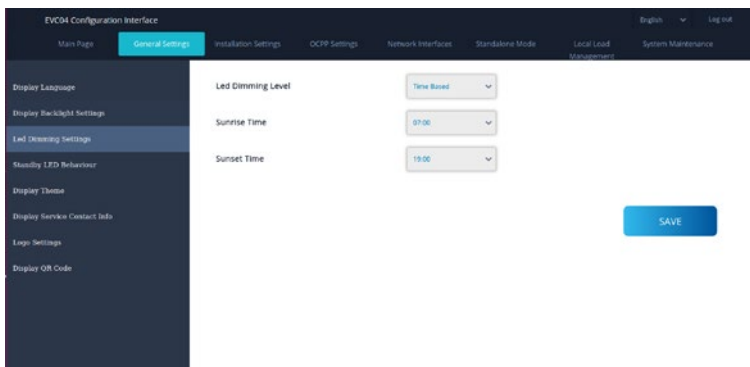

Figure-37

5.6.2.4 - Standby LED Behaviour:

You can select HMI standby LED behaviour from the general settings page. Standby Led Behaviour can be on or off.

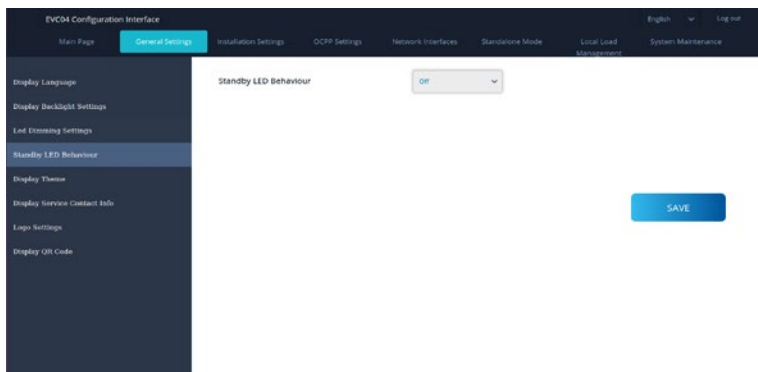

Figure-38

5.6.2.5 - Display Theme:

You can make display theme selection from "Display Theme" menu as shown below.

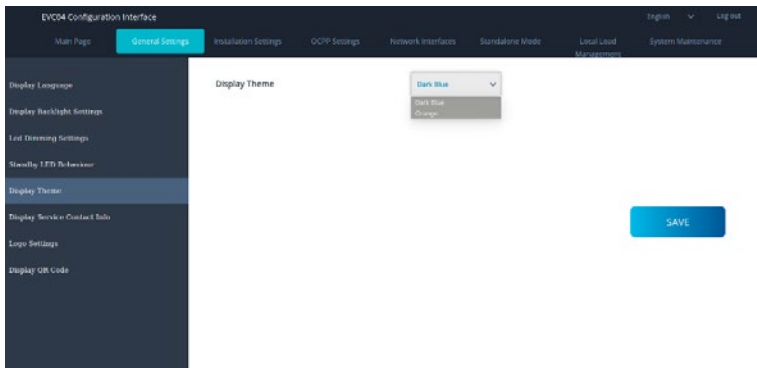

Figure-39

5.6.2.6 - Display Service Contact Info:

Technician can enter the requested contact info of the service from this menu to be able to shown in display.

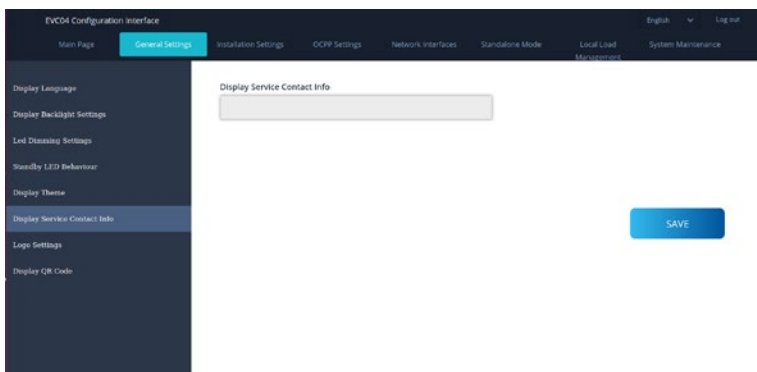

Figure-40

5.6.2.7 - Logo Settings:

Technician can change the display logo of the station from the logo settings by uploading the required logo. The new logo should be in 80x80 pixels and .png format.

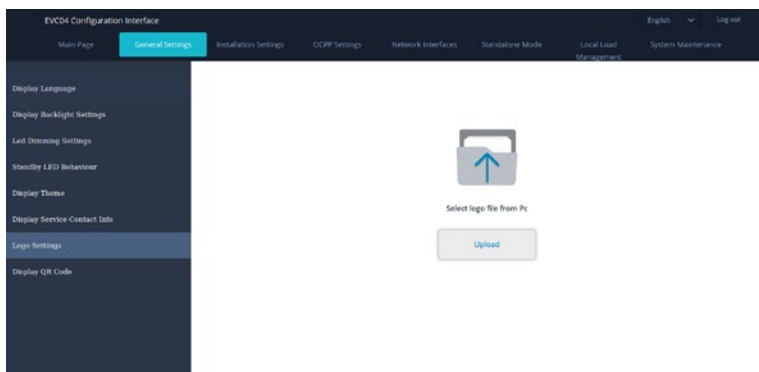

Figure-41

5.6.2.8 - Display QR Code:

You can upload or remove QR code from the general settings page.

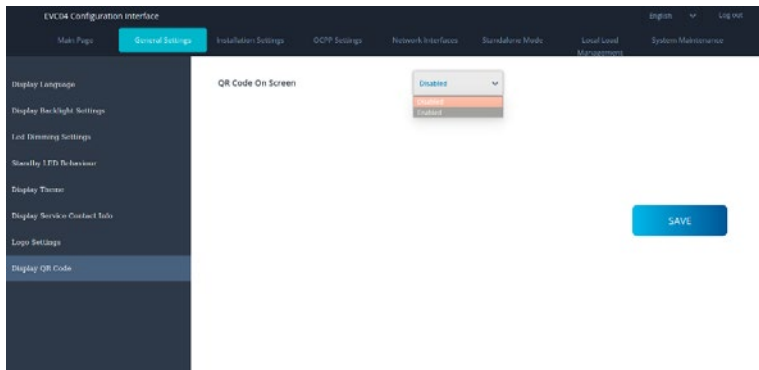

Figure-42

5.6.3 - INSTALLATION SETTINGS

5.6.3.1 - Earthing system:

Earthing System Tab in web configuration interface. If Earthing Type is selected as IT, the protective earth error check is disabled. In web configuration interface, earthing type is "TN/TT" by default.

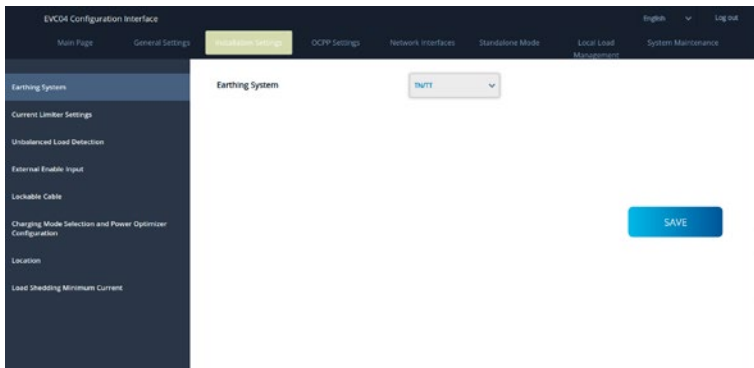

Figure-43

5.6.3.2 - Current Limiter Settings:

Current Limiter Phase information can be adjusted in this menu. Also Current Limiter Value can be written manually between 6-32A. If a value below 6A is written, a warning will be shown to write minimum 6A.

Note: For example, if the charging station's current limiter is set to 16A in hardware and it is written and set 32A in web configuration interface, the station takes 16A.

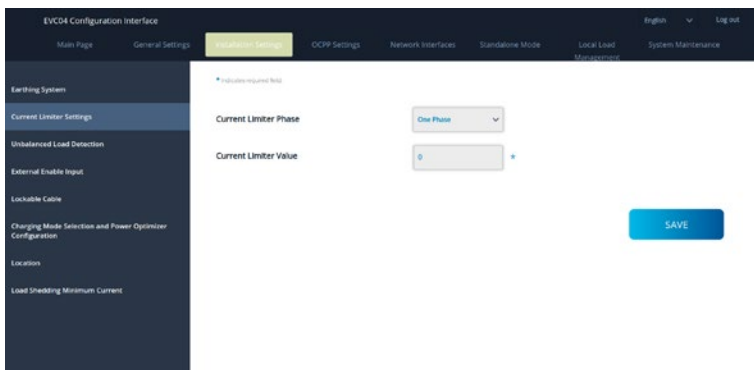

Figure-44

5.6.3.3 - Unbalanced Load Detection:

This feature is disabled in webconfiguration interface by default. Unbalanced load detection function detects too much difference in power drawn between phases. If any phase draws more than 4.6 kW of power (last one minute average) than the other phases, there is an unbalanced load. With this feature, this situation is detected and current limitation is made so that the phases does not exceed this limit value.

For example,

- Phase 1 Power: 3 kW,
- Phase 2 Power: 3 kW,
- Phase 3 Power: 1 kW.
- Power Limit for Phase1 or Phase2 will be 5,6 kW (1 kW + 4.6 kW)
- If voltage is 230, current limit will be $5600/230 = 24A$.

General Formula;

- Power Limit = (Minimum Power + 4.6) (kW)
- Current limit = Power Limit / Voltage (Amps)

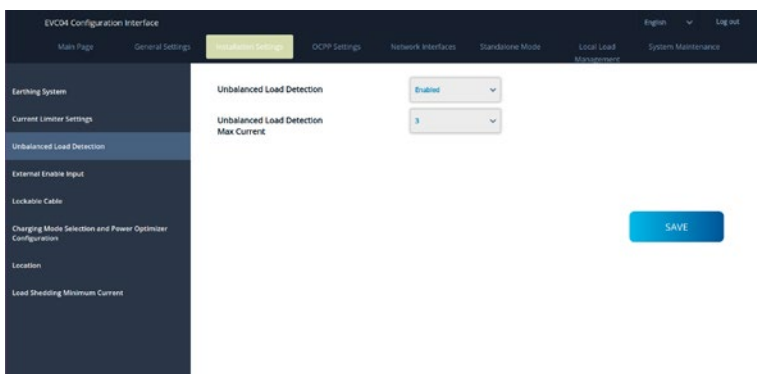

Figure-45

5.6.3.4 - External Enabled Input:

Default value for this option is set as disabled but if the user wants to use external enable input function, the setting should be set as "enabled".

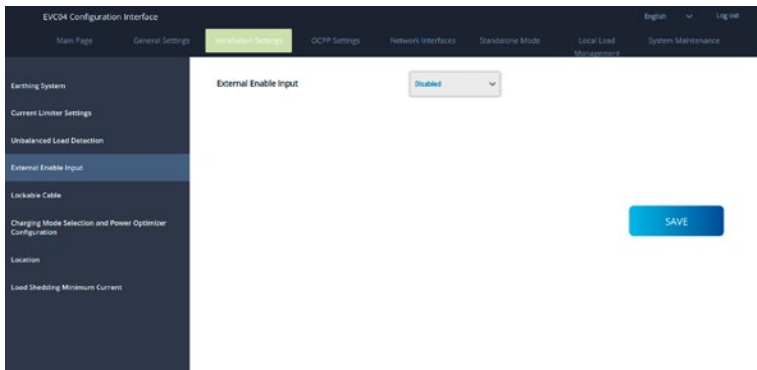

Figure-46

5.6.3.5 - Lockable Cable:

This option is set “disabled” in web configuration user interface by default.

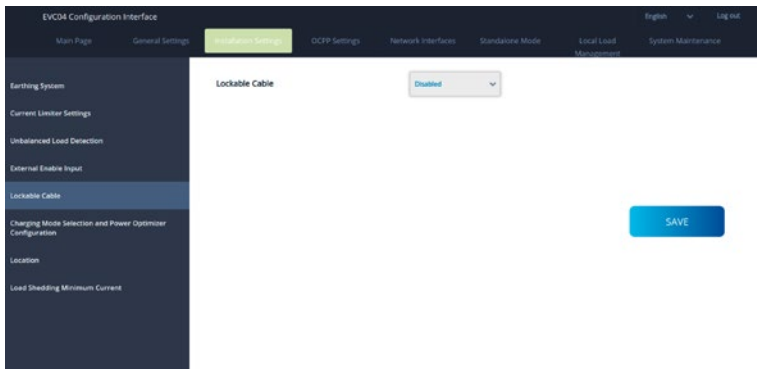

Figure-47

5.6.3.6 - Charging Mode Selection and Power Optimizer Configuration:

Technician can select operation mode from the installation settings page. You can select operation mode, Power Total Current Limit and Power Optimizer External Meter.

Operation Mode can be Normal, Peak / Off-Peak, TIC. Power Optimizer Total Current Limit can be Disabled or can take values between 10 and 100. Power Optimizer External Meter. can be Not Selected Klefr 6924 / 6934 Garo GNM3T / GNM3D Embedded Power Optimizer with CTP1

Slimmeter operation Mod When TIC selected in Operation Mode , Power Optimizer Total Current Limit and Power Optimizer External Meter can not be selected.

When Power Optimizer Total Current Limit is Disabled, Power Optimizer External Meter can not be selected.

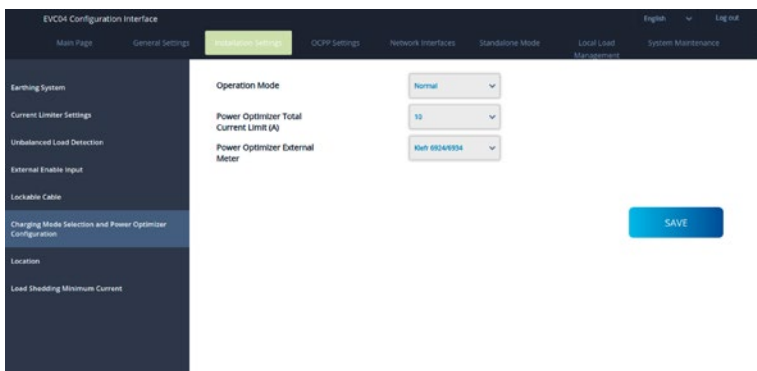

Figure-48

5.6.3.7 - Location

In this part, you can select Location from Web configuration. Location options are Indoor and Outdoor.

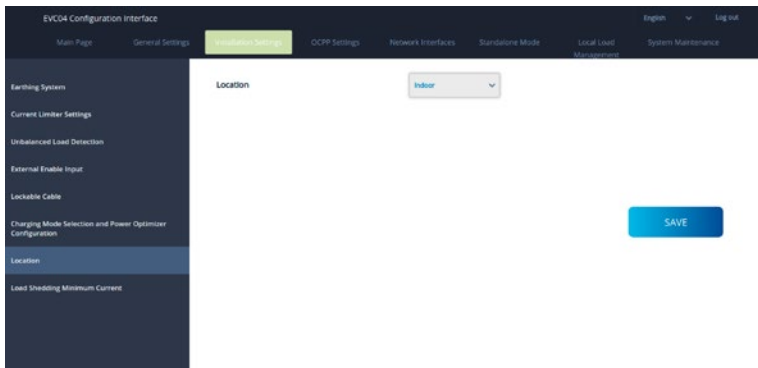

Figure-49

5.6.3.8 - Load Shedding Minimum Current

Load Shedding Minimum Current Technician can select Load shedding minimum current from the installation settings page. This parameter can take values between 0 and Current Limiter Value. Current Limiter Value can be set on Current Limiter Settings.

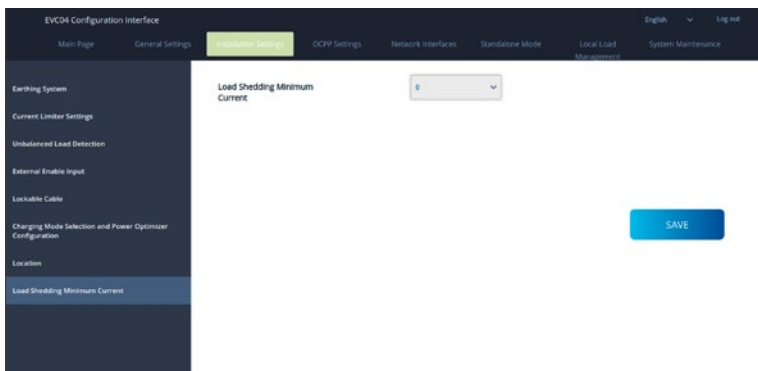

Figure-50

5.6.4 - CHANGE OCPP SETTINGS OF THE DEVICE

OCPP Connection: If you select mode as “Enabled”; you should type all fields in the connection settings and configuration parameters sections are enable in the below.

For now, the only available OCPP version is OCPP 1.6, so it will be selected as default.

The Central System Address and Charge Point Id are mandatory fields for saving this page.

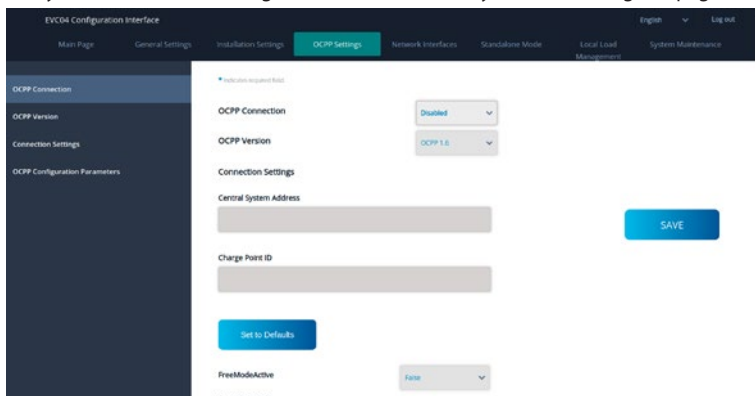

The screenshot shows the 'EVCM Configuration Interface' with the 'OCPP Settings' tab selected. The left sidebar contains a menu with 'OCPP Connection', 'OCPP Version', 'Connection Settings', and 'OCPP Configuration Parameters'. The main content area shows the following settings:

- OCPP Connection: Disabled (dropdown)
- OCPP Version: OCPP 1.6 (dropdown)
- Connection Settings:
 - Central System Address: (empty text field)
 - Charge Point ID: (empty text field)
- FreeModeActive: False (dropdown)

Buttons include 'Set to Defaults' (bottom left) and 'SAVE' (bottom right).

Figure-51

You can set OCPP configuration parameters to their default values by clicking “Set to Defaults” button. You can select the OCPP settings type you want from the menu which is at the left side of the page. For example OCPP Connection, OCPP Version, Connection Settings and OCPP Configuration Parameters.

Then, click “Save” button.

Please be careful for your entered values because the system does not accept the unsuitable values and gives the warning. In this case, values will not be saved. Then the page does not to be redirected the main page so you should check your values.

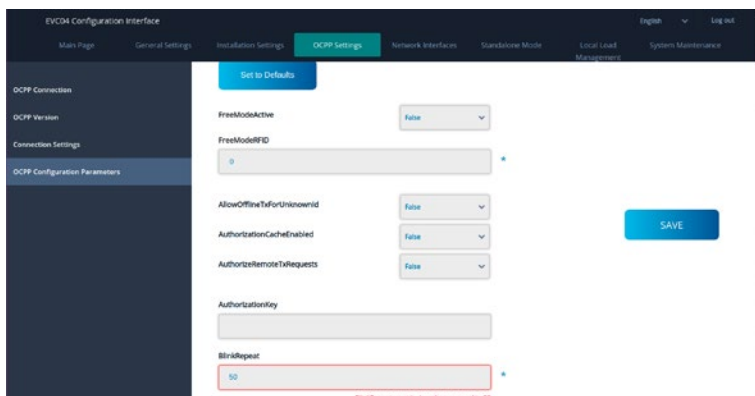

The screenshot shows the 'EVCM Configuration Interface' with the 'OCPP Settings' tab selected. The left sidebar contains a menu with 'OCPP Connection', 'OCPP Version', 'Connection Settings', and 'OCPP Configuration Parameters'. The main content area shows the following settings:

- FreeModeActive: False (dropdown)
- FreeModeRFID: (empty text field)
- AllowOfflineTxForknownid: False (dropdown)
- AuthorizationCacheEnabled: False (dropdown)
- AuthorizeRemoteTxRequests: False (dropdown)
- AuthorizationKey: (empty text field)
- BlinkRepeat: 50 (text field)

A red warning message is displayed below the 'BlinkRepeat' field: "BlinkRepeat must be less than or equal to 50". Buttons include 'Set to Defaults' (top left) and 'SAVE' (bottom right).

Figure-52

Also if you make changes and you don't save them before the leaving that page, you will see the warning as shown below.

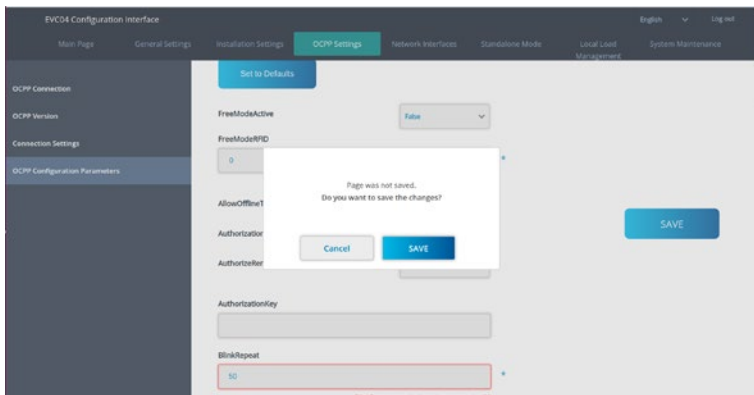

Figure-53

5.6.5 - CHANGE NETWORK INTERFACES SETTINGS OF THE DEVICE

There are three types of network interfaces in this page; Cellular, Ethernet, Wi-Fi and Wi-Fi Hotspot. Select interfaces' modes as "Enabled" if you want to activate it.

If you select Ethernet or Wi-Fi IP Settings as "Static"; "IP Address", "Network Mask", "Default Gateway" and "Primary DNS" spaces are mandatory.

If you set Wi-Fi as enabled, "SSID", "Password" and "Security" are mandatory.

You should fill all spaces in suitable formats.

CELLULAR

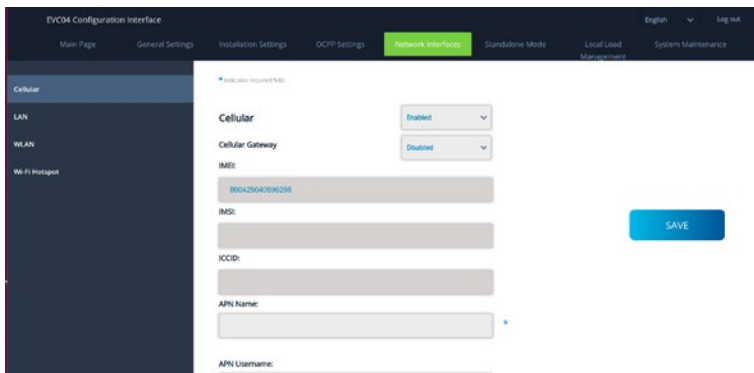

Figure-54

LAN

The screenshot shows the 'Network Interfaces' tab in the EVCD4 Configuration Interface. The 'LAN' section is active. It includes a 'MAC Address' field with the value '68:47:49:73:50:20'. Below it is an 'IP Setting' dropdown menu set to 'Static'. The 'IP Address' field contains '192.168.0.10', and the 'Network Mask' field contains '255.255.255.0'. There is a 'Default Gateway' field which is currently empty. A blue 'SAVE' button is located on the right side of the form.

Figure-55

WLAN

The screenshot shows the 'Network Interfaces' tab in the EVCD4 Configuration Interface. The 'WLAN' section is active. It includes an 'Enabled' dropdown menu. The 'MAC Address' field contains 'CC:08:C1:61:9A:8F'. Below it is an 'SSID' field. The 'Password' field is empty. The 'Security' dropdown menu is set to 'Select security type'. The 'IP Setting' dropdown menu is set to 'Please select IP Setting'. A blue 'SAVE' button is located on the right side of the form.

Figure-56

When you finish it, click "Save" button.

WIFI HOTSPOT

Details are described in section "OPENING WEB CONFIGURATION INTERFACE VIA WIFI HOTSPOT"

The screenshot shows the 'Network Interfaces' tab in the EVCD4 Configuration Interface. The 'WiFi Hotspot' section is active. It includes a 'Turn on during boot' dropdown menu set to 'Enabled'. Below it is an 'Auto turn-off timeout' dropdown menu set to '5'. The 'SSID' field is empty. The 'Password' field is empty. A blue 'SAVE' button is located on the right side of the form.

Figure-57

5.6.6 - CHANGE STANDALONE MODE SETTINGS OF THE DEVICE

If you have set OCPP as enabled in OCPP settings before, standalone mode cannot be selected. The mode list and "Save" button will be disabled in this situation.

Otherwise, you can select standalone mode from the list. There are three modes in the list:

- Select "RFID Local List" mode to authenticate a RFID local list which will be entered by you. You can make an addition or deletion from the RFID local list later.
- Select "Accept All RFID's" mode to authenticate all RFID's.
- Select "Autostart" mode to allow charging without the need for authorization. It will be enough to plug to start charging.

If you are done with mode selection, click "Save" button and reboot the device.

Note: Drive green application can be used in all modes in standalone mode.

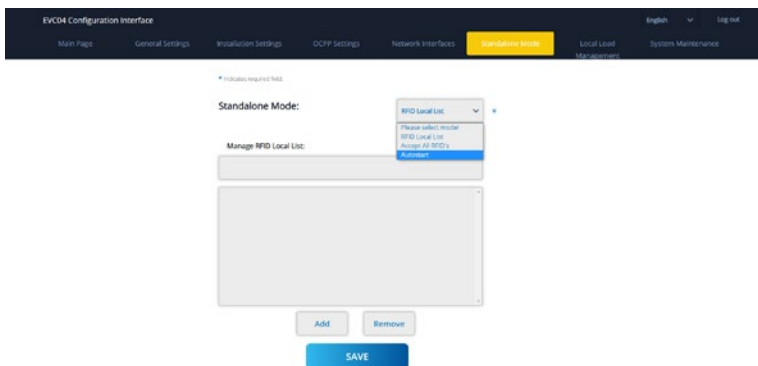

Figure-58

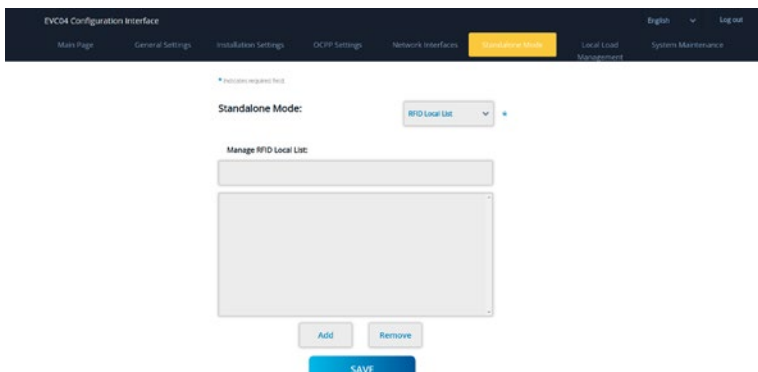

Figure-59

5.6.7 - LOCAL LOAD MANAGEMENT OF THE DEVICE

5.6.7.1 - Modbus TCP/IP Protocol Parameters

Defenzo Wallbox AC22 Smart charging station acts as a slave device in the Modbus TCP/IP communication. Charging station should be in the same network with the master device or a proper routing should be applied to provide communication between slave and the master devices in different sub networks. Each charging station should have different IP address. Modbus TCP communication port number is 502 and Modbus Unit ID is 255 for charging stations. There can be only one active Modbus master connection at any time. When a new Modbus connection is established, the master is expected to set the Failsafe Current, Failsafe Timeout and Charging Current registers immediately. The master also periodically sets the Alive register to indicate that the connection is still alive. If the master does not update the value of the alive register until the failsafe timeout, the device switches to the failsafe state; TCP socket is terminated and failsafe current becomes active. As the update period of the Alive register, half of the failsafe timeout is recommended.

5.6.7.2 - Static Management

For static management, a power limit can be set to the load management group and the charger won't go above the power limit.

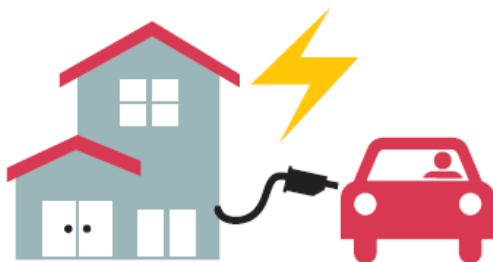

Figure-60

5.6.7.3 - Dynamic Management

With the help of dedicated power optimizer option, Charging station can manage the power limit based on the available power. When the household appliances consumes more, the charger consumes less and doesn't overload the main switch.



Figure-61

5.6.7.4 - Star Topology

In star network topology, all chargers are connected to the master station via a network switch or router. This topology needs cabling between each charging station and the central switch. This topology is more reliable than daisy chain topology since each charging station has its own connectivity to the network switch. For connection of each station to the central switch, Cat5e or Cat6 Ethernet cables can be used up to 100 meters each.

For the IP configuration of the network, either the router may have DHCP server or the master charging station can be configured as DHCP server. If you use a router with a DHCP server, you need to configure all charging stations including the master station LAN IP address setting as "Dynamic" from "Network Interfaces" menu. In this scenario, all the charging stations get their IP addresses from central DHCP server.

If you use a router or a L2-switch without DHCP server, you need to configure master charging station LAN IP settings to DHCP server and slave charging station LAN IP setting to "Dynamic" from "Network Interfaces" menu. In this scenario, slave charging stations get their IP addresses from master charging station.

Block diagrams for static and dynamic supply in star network topology are provided as below.

5.6.7.4.1 - Static Supply Star Topology:

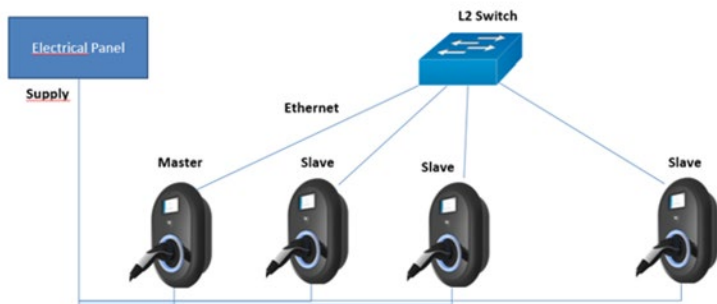

Figure-62

Local Load Management configuration of static supply. 5.6.7.4.2 - Dynamic Supply Star Topology:

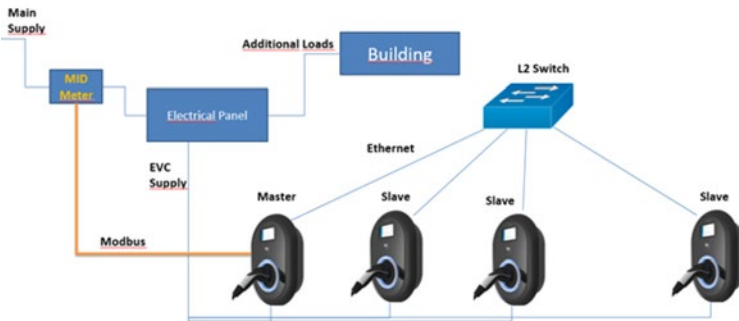

Figure-63

5.6.7.5 - Charging Station Role

5.6.7.5.1 - Configuration of Slave Charging Stations

The charging station is preconfigure to DHCP mode in factory. If you need to connect to the charging station's web configuration interface directly using a computer, rather than using a router having DHCP server, steps below should be followed:

- Make sure the charging station is powered-off and open the front cover of your charger which is mentioned in installation guideline.
- Toggle the second position of DIP switch which is on the smart board of the charger shown in figure-below After that please turn on the charger again.
- Charging station sets the Ethernet port to 192.168.0.10 address statically and subnet mask will be set to 255.255.255.0

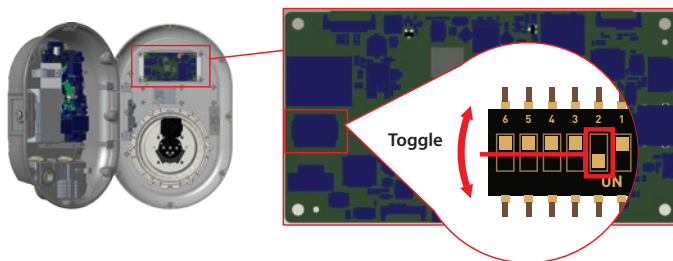

Figure-64

Open your web browser and type 192.168.0.10 which is IP address of smart board.

You will see login page on your browser;

When you want to enter to the web configuration interface in the first time, you will see the warning as "We recommend you to change your default password from system maintenance menu".

You can enter the system with:

- Default username = admin
- Default password = admin

You can change password with Change Password Button in login page or Administration Password section in the System Maintenance tab.

Attention: For web configuration interface accessibility problems; Web browsers usually save some information from websites in its cache and cookies. Forcing Refresh or Clearing (depending on your operating system and browser) them fixes certain problems, like loading or formatting issues on web page.

Load management option is "disabled" by default. After accessing to configuration web interface, you need to tab "Local Load Management" menu and select "Master/Slave" in "Load management Option". "Charge Point Role" should be selected as "Slave" as shown in below menus.

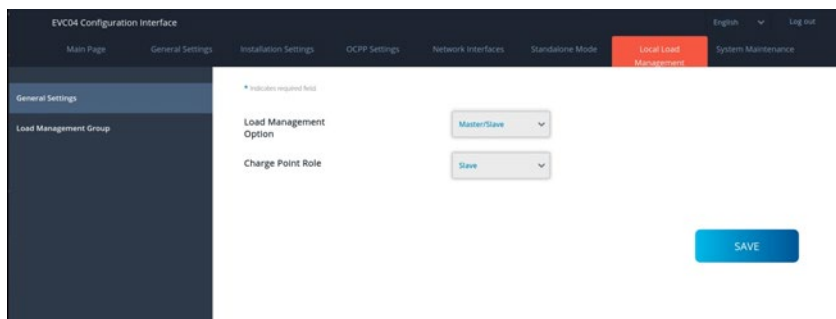

Figure-65

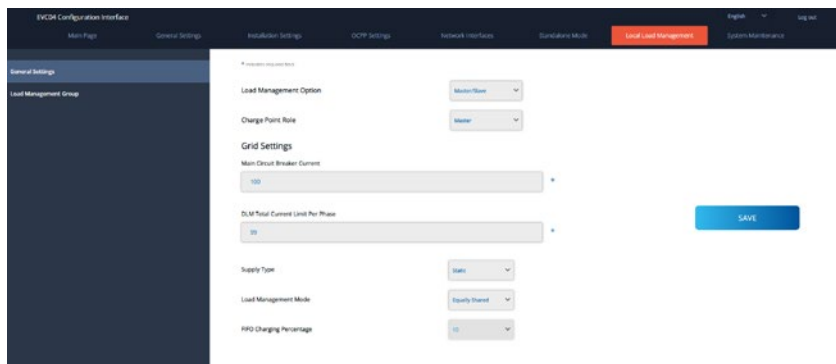

Figure-66

The slave charging stations should be set as DHCP client as shown in image below. Note that, this setting causes disconnection from configuration web interface of the charging station, so this setting should be the latest setting in slave configuration of the charging station.

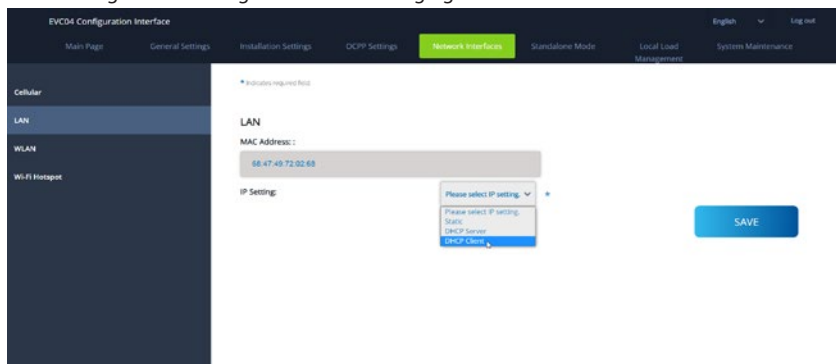

Figure-67

5.6.7.5.2 - Configuration of Master Charging Station

The charging station is preconfigure to DHCP mode in factory. If you need to connect to the charging station's web configuration interface directly using a computer, rather than using a router having DHCP server, steps below should be followed:

- Make sure the charging station is powered-off and open the front cover of your charger which is mentioned in installation guideline.
- Toggle the second position of DIP switch which is on the smart board of the charger shown in figure below After that please turn on the charger again.
- Charging station sets the Ethernet port to 192.168.0.10 address statically and subnet mask will be set to 255.255.255.0

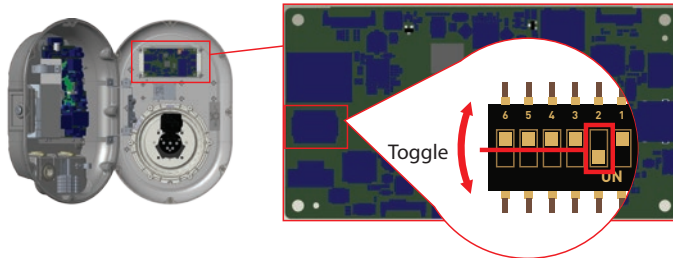

Figure-68

Open your web browser and type 192.168.0.10 which is IP address of smart board.

You will see login page on your browser;

When you want to enter to the web configuration interface in the first time, you will see the warning as “We recommend you to change your default password from system maintenance menu”.

You can enter the system with:

- Default username = admin
- Default password = admin

You can change password with Change Password Button in login page or Administration Password section in the System Maintenance tab.

Attention: For web configuration interface accessibility problems; Web browsers usually save some information from websites in its cache and cookies. Forcing Refresh or Clearing (depending on your operating system and browser) them fixes certain problems, like loading or formatting issues on web page.

The master charging station should be set as DHCP server with a valid static IP address E.g. 192.168.0.10 with DHCP start and end IP addresses 192.168.0.50 and 192.168.0.100, respectively, as shown in the image below.

Note that if there is an external DHCP server in the local network, you also need to set master charging station to DHCP client.

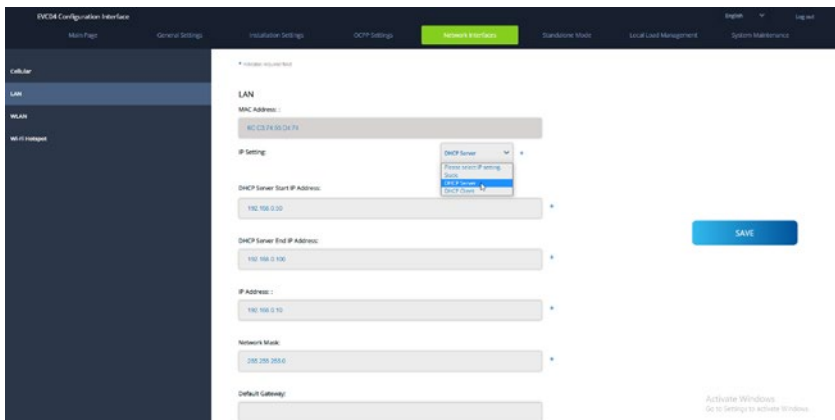

Figure-69

Load management option is “disabled” by default. After accessing to configuration web interface, you need to tab “Local Load Management” menu and select “Master/Slave” in “Load management Option”. “Charge Point Role” should be selected as “Master” as shown in the image below.

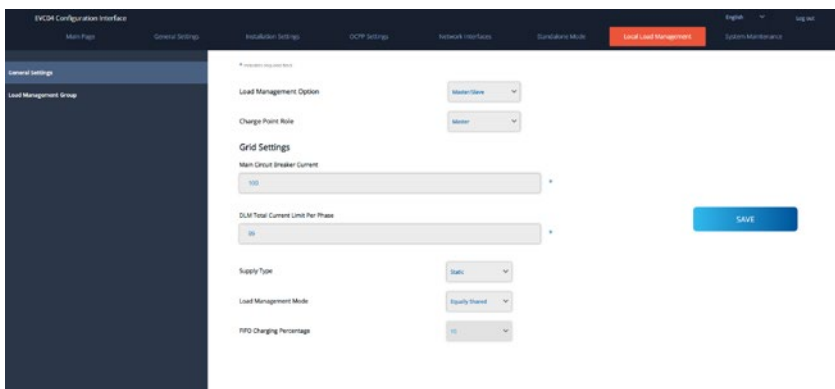

Figure-70

Master charging station has additional configuration settings for dynamic load management group.

“DLM Total Current Limit Per Phase” value should be set to the maximum allowed current which can be drawn from the upstream electrical circuit.

“Supply Type” should be set according to the load management type such as “static” current limit or “dynamic” current limit. For static current limit, “static” option should be selected. For dynamic current measurement, “MID” should be selected in “supply type”. Note that dynamic current limit setting needs optional current measurement accessories.

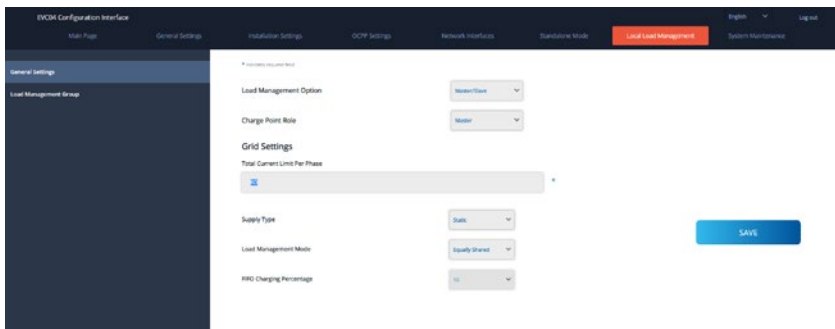

Figure-71

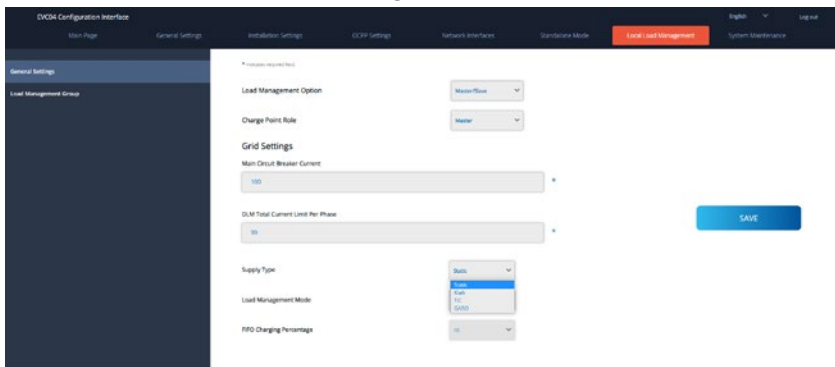

Figure-72

Appropriate load management mode can be selected from three options as “Equally shared”, “First in First out” and “Combined” modes. Combined mode needs extra configuration as “Fifo Charging Percentage” which effects the share between equally shared and first-in first-out calculations of the load management algorithm.

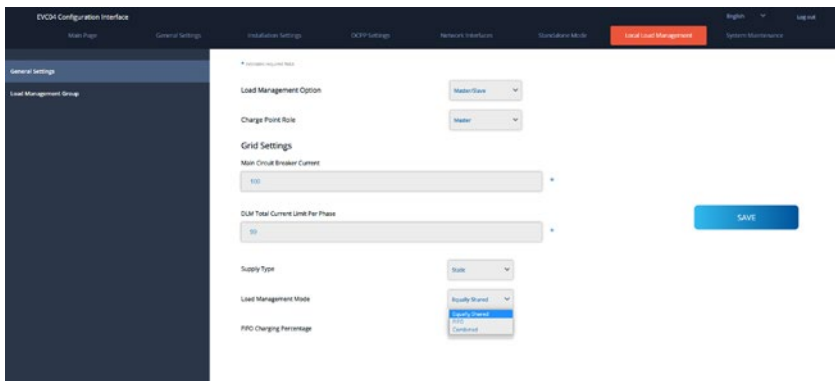

Figure-73

There are 3 different scenarios of load management usage:

5.6.7.6 - Equally shared

All available power is distributed equally to all EVs connected. This is more suitable for workplace or condominium chargings where the cars are parked for a considerable period of time.

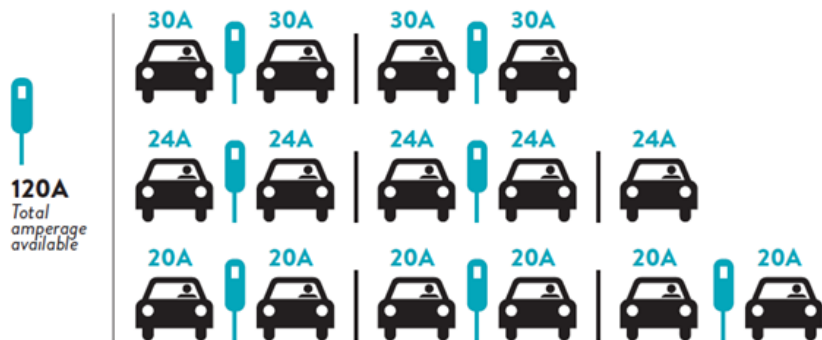

Figure-74

5.6.7.7 - FiFo (First in - First Out)

This type of load management is more oriented for fleets in order to let them have more fully charged EVs when they need. The available power is redistributed and when a new EV arrives, it waits until an EV finishes its charge or leaves the charging point.

EVSE/T _p	G _M =120A						G _M =80A	
	T ₁	T ₂	T ₃	T ₄	T ₅	T ₆	T ₇	T ₈
1	32A	32A	32A	32A	16A ↓	6A	6A	
2	32A	32A	32A	32A	32A	32A	32A	
3	32A	32A	32A	32A	32A	32A	32A	
4	32A	24A	24A	18A	32A	32A	6A	
5	32A	24A	6A	6A	8A	24A	6A	

* T_p: Time Period, G_M = Maximum Grid allocated for the chargers. Available maximum current for each EVSE in a certain T_p is indicated in black color. Charging current which is drawn by EV is indicated in Blue color. An EV drawing less current is indicated by "↓" symbol.

Figure-75

5.6.7.8 - Combined Load Management

Combined load management is a combination of FiFo and Equally shared methods. A percentage of total power allocated for EV charging cluster can be set and this percentage of total power distributed to all EVs according to FiFo and the remaining power will be delivered as equally shared principal to all EVs.

F%=50	G _M =120A					G _M =80A		G _M =29A	G _M =30A	
EVSE/T _p	T ₁	T ₂	T ₃	T ₄	T ₅	T ₆	T ₇	T ₈	T ₉	T ₁₀
1	32A	32A	32A	32A	20A ↓	6A ↓	6A	8A		6A
2	32A	32A	32A	32A	32A	32A	32A	32A	32A	6A
3	32A	32A	32A	32A	32A	32A	26A	28A	6A	6A
4	32A	24A	24A	12A	24A	32A	8A	10A	6A	6A
5	32A	24A	12A	12A	12A	18A	8A	10A	6A	6A

* T_p: Time Period, G_M = Maximum Grid allocated for the chargers. Available maximum current for each EVSE in a certain T_p is indicated in black color. Charging current which is drawn by EV is indicated in Blue color. A EV drawing less current is indicated by "↓" symbol.

Figure-76

After the basic load management configurations are finished, be sure to connect all of the slave charging stations to the master charging station through daisy chain or star network topology. When all the charging stations are ready to communicate with the master charging station, click "UPDATE DLM GROUP" button in "Load Management Group" menu. When "UPDATE DLM GROUP" button is clicked, master charging station starts slave discovery mode and automatically finds and lists slave charging stations in the list including master charging station itself as connector.

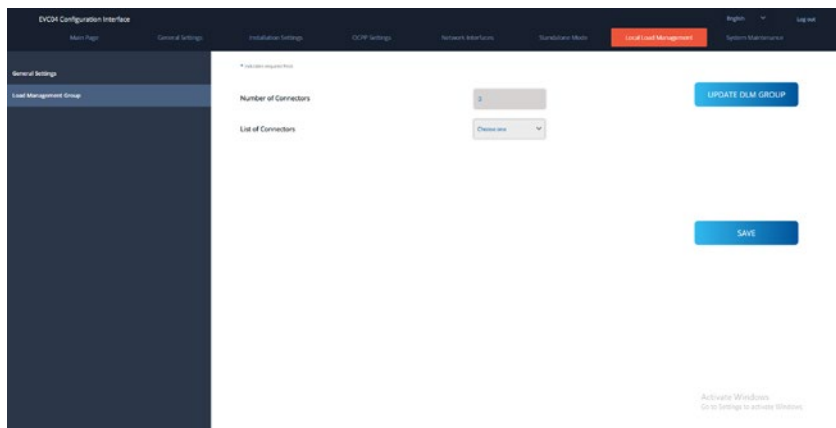

Figure-77

After master charging station discovers all the slave charging stations, then you can make other required settings of each connector one by one.

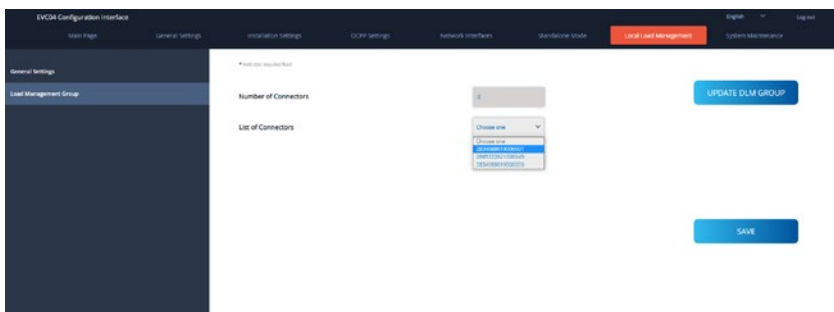

Figure-78

If the selected connector is required to be prioritized over the other charging stations, you can set “VIP Charging” as enabled as shown in the image below.

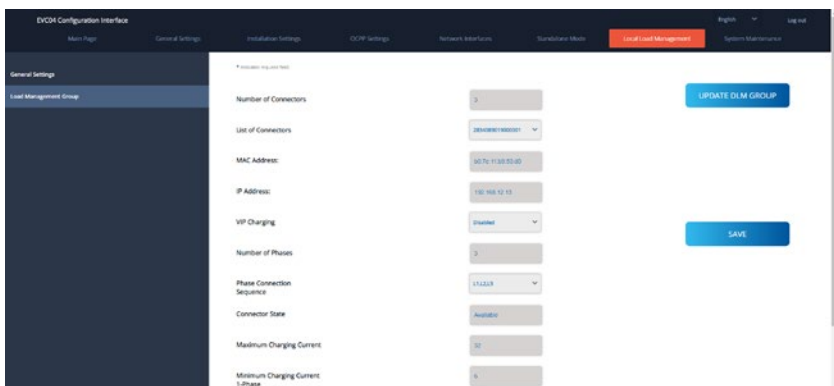

Figure-79

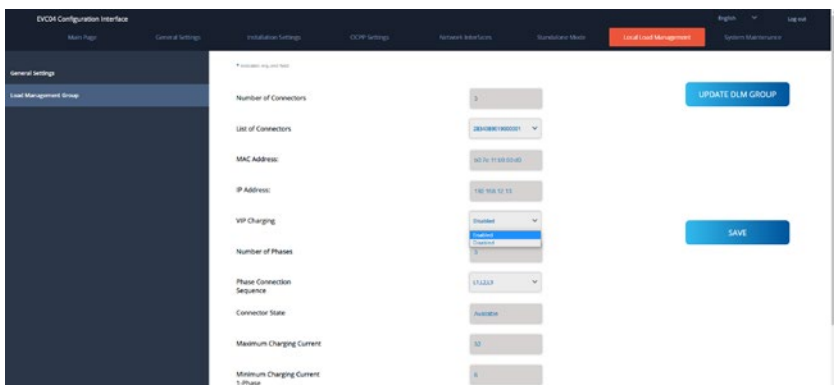

Figure-80

For setting the actual phase connection sequence of each charging station, you need to select correct sequence from the dropdown menu as shown in the image below.

Note that if the charging station has only one phase supply, then you just need to select correct phase number from the drop down menu.

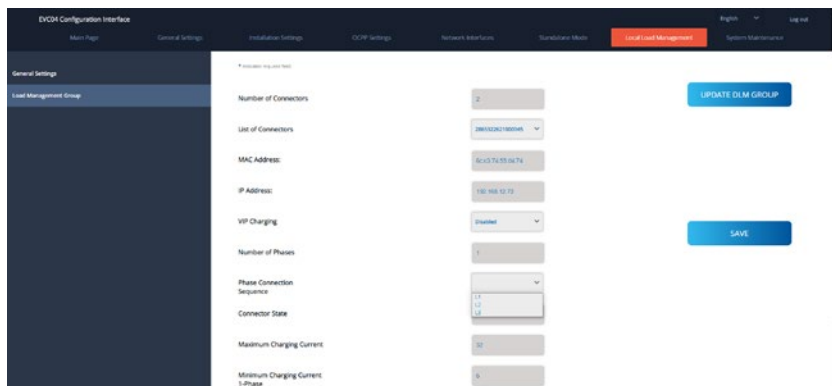

Figure-81

Other parameters are just read only information from the connectors, which can be updated to the latest values by refreshing the configuration web interface.

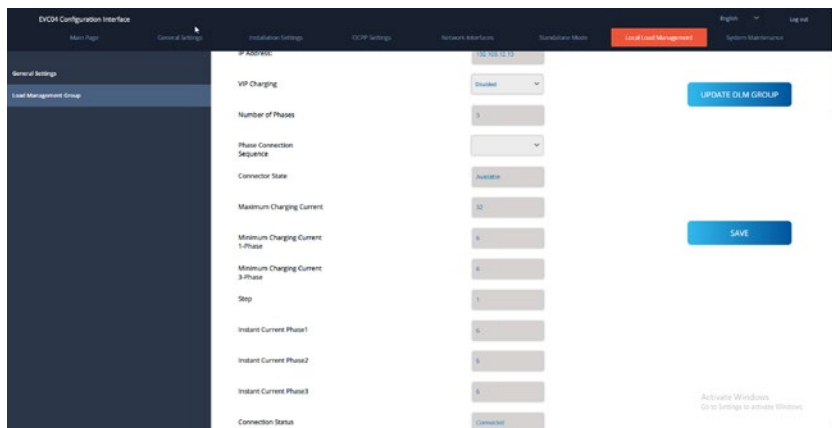

Figure-82

5.6.8 - MAKING SYSTEM MAINTENANCE OF THE DEVICE

In **LOG FILES Page**, you can download OCPP or HMI logs by clicking buttons. Download log files will be shown after a few seconds.

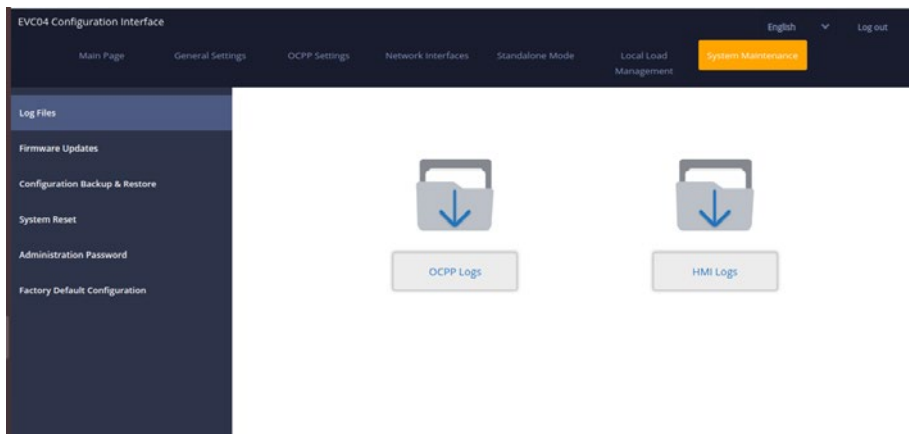

Figure-83

In **FIRMWARE UPDATE Page**, you can upload the firmware update file from your PC by clicking "Upload" button.

After the file is uploaded, you can click "Update" button to start the firmware update.

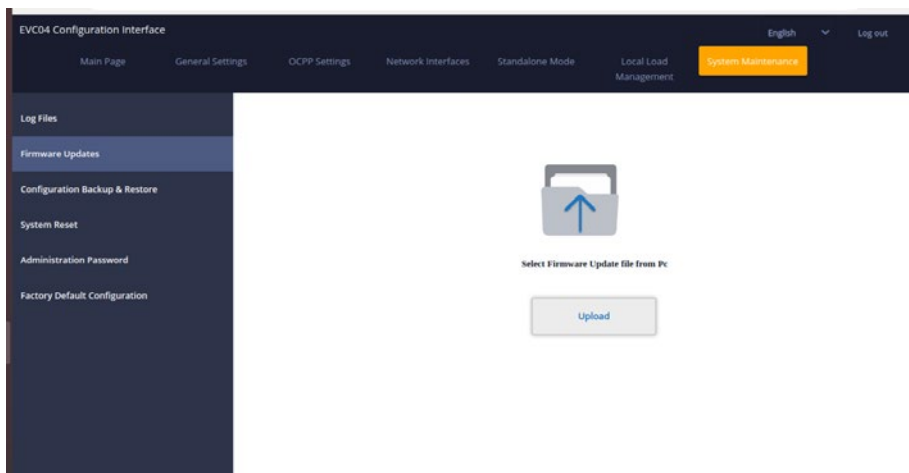

Figure-84

When update is started, your charger's LED indication will be seen as constant green or constant red. If your charger has display, you can see the firmware update screen in display. See to Firmware Update Screen Flow section. After the firmware update is finished, your charger will restart automatically. You can see the latest firmware version of your charger from webconfig UI in main page.

5.6.9 - FIRMWARE UPDATE SCREEN FLOW (With Display Models)

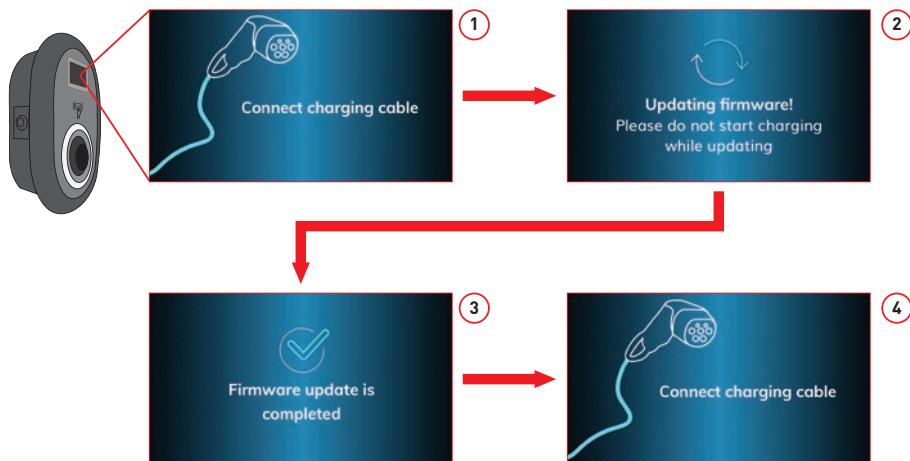

Figure-85

1. Firmware update is sent and devices uploads it.
2. hen devices software is in updating status.
3. After 5 second screen turns back to opening screen.
4. Connect charging cable.

In **CONFIGURATION AND BACKUP Page**, you can backup of the sytem. If you want to restore you can click the Restore Config File button and upload the backup file. The system only accepts the .bak files.

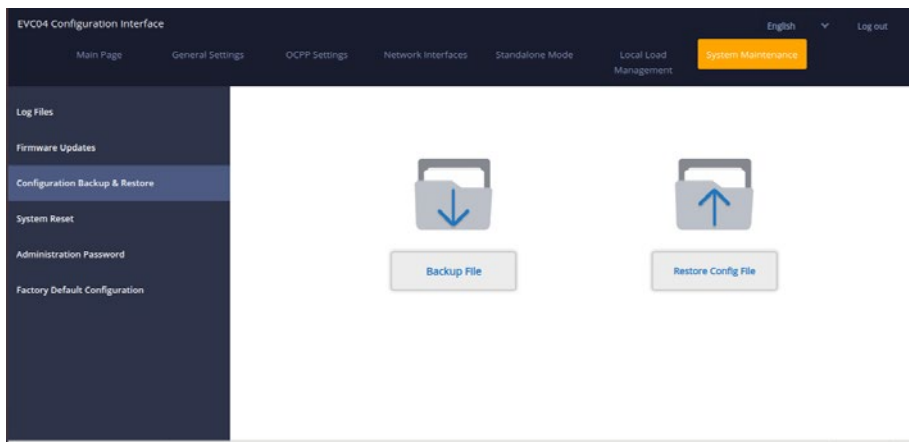

Figure-86

In **SYSTEM RESET Page**, you can make Soft Reset and Hard Reset by clicking the buttons.

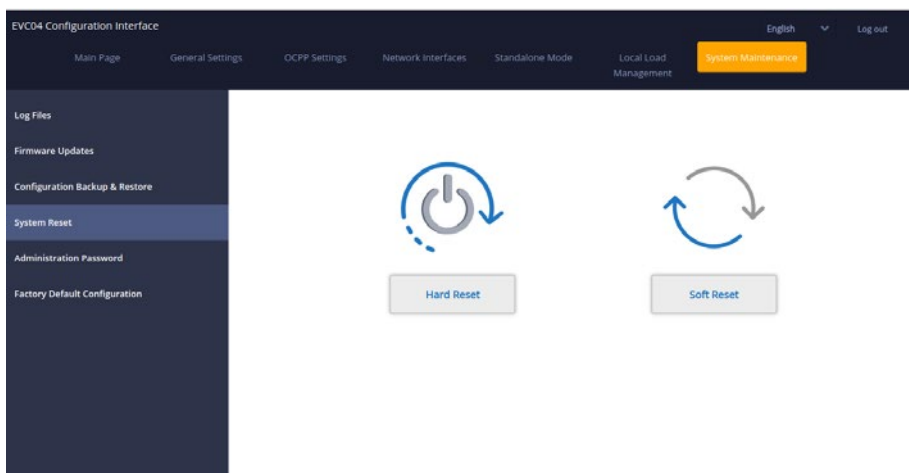
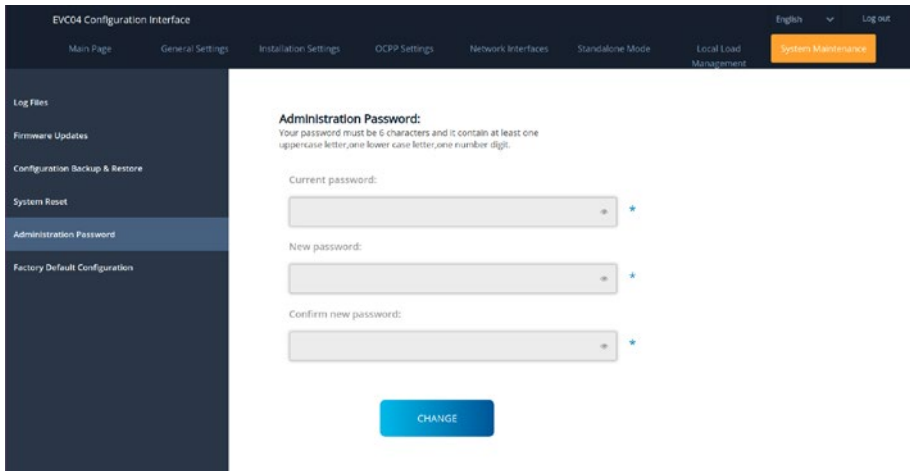

Figure-87

In **ADMINISTRATION PASSWORD Page**, you can change the web config's login password.

New password must contain at least 1 lowercase letter, 1 uppercase letter, 1 numeric character and minimum 6 characters.

All spaces are mandatory.



The screenshot shows the 'Administration Password' page in the EVCD4 Configuration Interface. The top navigation bar includes 'Main Page', 'General Settings', 'Installation Settings', 'OCPP Settings', 'Network Interfaces', 'Standalone Mode', 'Local Load Management', and 'System Maintenance'. The left sidebar lists 'Log Files', 'Firmware Updates', 'Configuration Backup & Restore', 'System Reset', 'Administration Password', and 'Factory Default Configuration'. The main content area is titled 'Administration Password:' and contains the instruction: 'Your password must be 6 characters and it contain at least one uppercase letter, one lower case letter, one number digit.' Below this are three input fields: 'Current password:', 'New password:', and 'Confirm new password:'. Each field has a blue star icon on the right. At the bottom of the form is a blue 'CHANGE' button.

Figure-88

In **FACTORY DEFAULT CONFIGURATION Page**, you can make factory reset to the device.

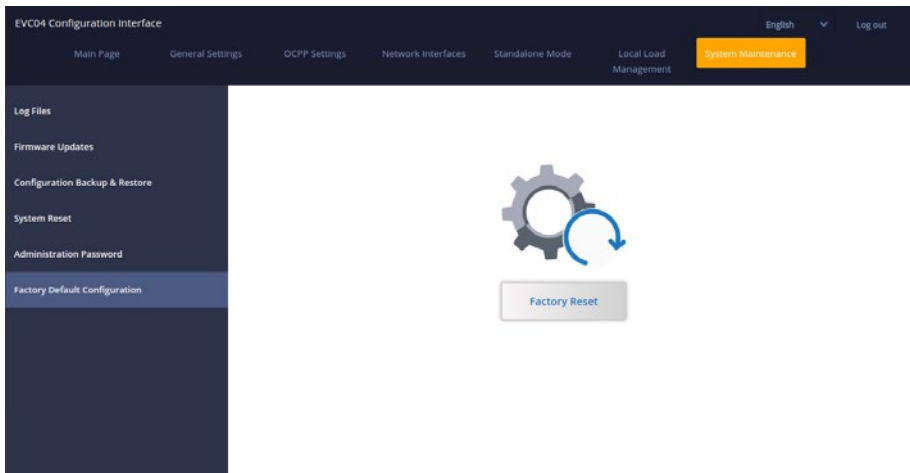

Figure-89

 **EFENZO**
WALLBOX AC

DISTRIBUTOR:

VIDIS SA

ul. Logistyczna 4
Bielany Wrocławskie
55-040 Kobierzyce
Poland

WWW.DEFENZO.PL