

LUNA-F & LUNA-U

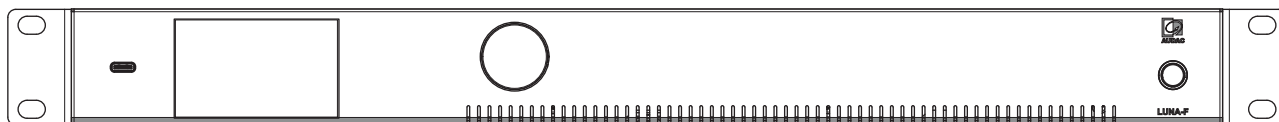

ADDITIONAL INFORMATION

This manual is put together with much care, and is as complete as could be on the publication date. However, updates on the specifications, functionality or software may have occurred since publication. To obtain the latest version of both manual and software, please visit the Audac website @ audac.eu.



Table of contents



Introduction	05
Networked sound & control audio processor	05
Precautions	06
Chapter 1	08
Connections and connectors	08
Network settings	09
Chapter 2	10
Overview front panel	10
Front panel description	10
Overview rear panel	11
Rear panel description	11
Chapter 3	13
User interface and configuration	13
Audac Touch™	14
Updating the system	17
Technical specifications	18
Audio characteristics	19

Introduction

Networked sound & control audio processor

The LUNA series is the next-generation audio matrix processor, offering highly flexible and scalable system solutions for audio distribution from medium-sized to the largest enterprise solutions. The internal structure provides unseen flexibility and a vast number of possibilities for an audio distribution system. The powerful DSPs (dual SHARC) combined with 32-bit ADC and DAC converters allow the most extensive signal processing with superb audio quality.

LUNA-F includes 8 Mic/Line Inputs, 8 flex channels that can be switched between 8 Mic/Line Inputs or Line level output, and 8 Line level outputs. Additionally, up to 64x64 Dante™/AES67 I/O Channels are available with primary and secondary ethernet ports, allowing the integration of the system with any Dante™/AES67 compatible audio over IP I/O units with redundancy.

LUNA-U includes 12 Mic/Line Inputs and 8 Line level outputs. Optionally, up to 32 Dante™/AES67 I/O Channels are available with a single ethernet port, allowing the integration of the system with any Dante™/AES67 compatible audio over IP I/O unit.

The flexible architecture allows fully flexible mapping of the signal path to any of the 32 mono or 16 stereo zones, while the powerful DSP resources provide unique processing features on all input channels, output channels, and zones. Dante-enabled paging microphones and smart wall panels make the complete system solution even more flexible and unique.

The internal Linux core brings the entire control of this system and family members together, while also accommodating messaging, event scheduling, and implementation possibilities for further Linux-based functions. Besides the full network control, other options like RS-232 and RS-485 are also implemented for third-party control. For your system solution, you can easily incorporate the control of the entire system and compatible devices into your user interface by using our simplified design and system control platform, AUDAC Touch™.

It is highly recommended to take online or in class Atellio Level-1 training and request Atellio Level-2 training from your distributor or reseller.

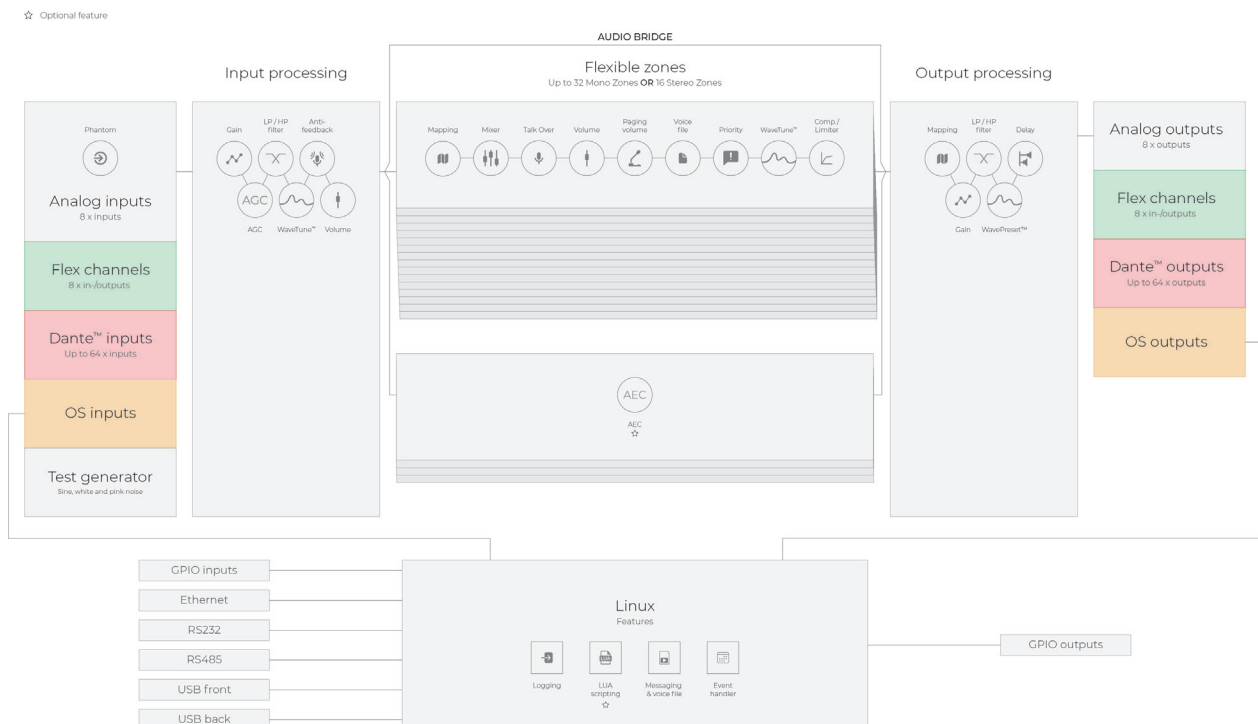

* Please note that this block diagram represents the functionality of LUNA-F, The LUNA-U is a variant of this block diagram

READ FOLLOWING INSTRUCTIONS FOR YOUR OWN SAFETY

ALWAYS KEEP THESE INSTRUCTIONS. NEVER THROW THEM AWAY

ALWAYS HANDLE THIS UNIT WITH CARE

HEED ALL WARNINGS

FOLLOW ALL INSTRUCTIONS

NEVER EXPOSE THIS EQUIPMENT TO RAIN, MOISTURE, ANY DRIPPING OR SPLASHING LIQUID. AND NEVER PLACE AN OBJECT FILLED WITH LIQUID ON TOP OF THIS DEVICE

NO NAKED FLAME SOURCES, SUCH AS LIGHTED CANDLES, SHOULD BE PLACED ON THE APPARATUS

DO NOT PLACE THIS UNIT IN AN ENCLOSED ENVIRONMENT SUCH AS A BOOKSHELF OR CLOSET. ENSURE THERE IS ADEQUATE VENTILATION TO COOL THE UNIT. DO NOT BLOCK THE VENTILATION OPENINGS.

DO NOT STICK ANY OBJECTS THROUGH THE VENTILATION OPENINGS.

DO NOT INSTALL THIS UNIT NEAR ANY HEAT SOURCES SUCH AS RADIATORS OR OTHER APPARATUS THAT PRODUCE HEAT

DO NOT PLACE THIS UNIT IN ENVIRONMENTS WHICH CONTAIN HIGH LEVELS OF DUST, HEAT, MOISTURE OR VIBRATION

THIS UNIT IS DEVELOPED FOR INDOOR USE ONLY. DO NOT USE IT OUTDOORS

PLACE THE UNIT ON A STABLE BASE OR MOUNT IT IN A STABLE RACK

ONLY USE ATTACHMENTS & ACCESSORIES SPECIFIED BY THE MANUFACTURER

UNPLUG THIS APPARATUS DURING LIGHTNING STORMS OR WHEN UNUSED FOR LONG PERIODS OF TIME

ONLY CONNECT THIS UNIT TO A MAINS SOCKET OUTLET WITH PROTECTIVE EARTHING CONNECTION

THE MAINS PLUG OR APPLIANCE COUPLER IS USED AS THE DISCONNECT DEVICE, SO THE DISCONNECT DEVICE SHALL BE READILY OPERABLE

USE THE APPARATUS ONLY IN MODERATE CLIMATES



CAUTION - SERVICING

This product contains no user serviceable parts. Refer all servicing to qualified service personnel. Do not perform any servicing (unless you are qualified to)



EC DECLARATION OF CONFORMITY

This product conforms to all the essential requirements and further relevant specifications described in following directives: 2014/30/EU (EMC), 2014/35/EU (LVD) & 2014/53/EU (RED).



WASTE ELECTRICAL AND ELECTRONIC EQUIPMENT (WEEE)

The WEEE marking indicates that this product should not be disposed with regular household waste at the end of its life cycle. This regulation is created to prevent any possible harm to the environment or human health.

This product is developed and manufactured with high quality materials and components which can be recycled and/or reused. Please dispose this product at your local collection point or recycling centre for electrical and electronic waste. This will make sure that it will be recycled in an environmentally friendly manner, and will help to protect the environment in which we all live.

POWER SUPPLY AND POWER CORD REQUIREMENTS

Power supply class I grounding requirements:

For protection from fault currents, the equipment shall be connected to a grounding terminal. Plug the system power cord into an AC outlet that provides a ground connection. Substitute cords may not provide adequate fault protection. Only use the power cord supplied with this product or an authorized/equivalent replacement.

Safety notices:

Denmark:

Apparatets stikprop skal tilsluttes en stikkontakt med jord, som giver forbindelse til stikproppens jord.

Finland:

Laite on liitettävä suojakoskettimilla varustettuun pistorasiaan.

Norway:

Apparatet må tilkoples jordet stikkontakt.

Sweden:

Apparaten skall anslutas till jordat uttag.

ATTENTION

The fuse (T1AL/250V) provides a safeguard function to the device. When replacing the fuse, make sure that the value of the replacement matches the value of the original fuse. Identification of a suitable replacement component or substitute shall be done by qualified technicians.

Connections

CONNECTION STANDARDS

The in- and output connections for AUDAC audio equipment are performed according to international wiring standards for professional audio equipment.

RJ45 (Network, PoE)

Network connections

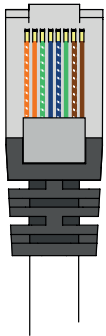

Pin 1	White-Orange
Pin 2	Orange
Pin 3	White-Green
Pin 4	Blue
Pin 5	White-Blue
Pin 6	Green
Pin 7	White-Brown
Pin 8	Brown

Network settings

STANDARD NETWORK SETTINGS

DHCP: **ON**

IP Address: Depending on DHCP

Subnet Mask: 255.255.255.0 (Depending on DHCP)

Gateway: 192.168.0.253 (Depending on DHCP)

DNS 1: 8.8.4.4 (Depending on DHCP)

DNS 2: 8.8.8.8 (Depending on DHCP)

3-Pin Terminal block:

For balanced line output connections.

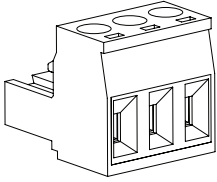

Left: Signal -
Right: Signal +
Center: Ground

For balanced line output connections.

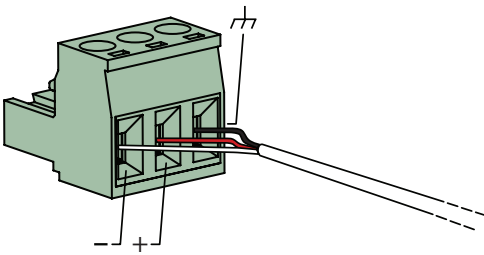

For unbalanced line input connections.

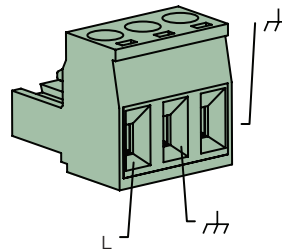

Overview front panel

The LUNA series have an elegant design. On the front panel has power button, 2.8" LCD display, a rotary function dial and a USB host.

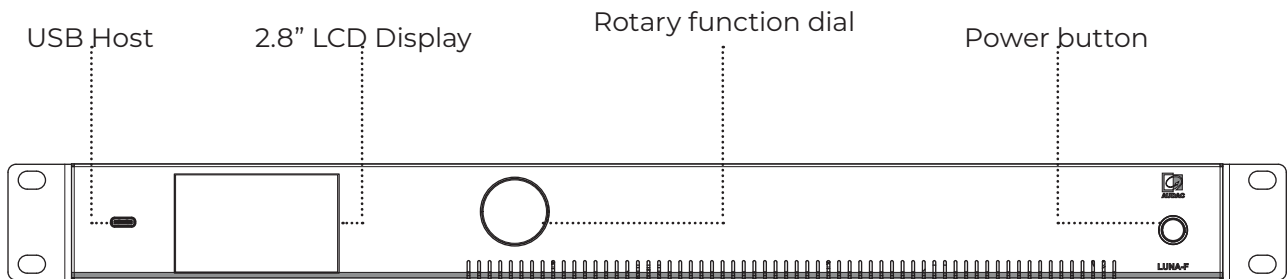

Front panel description

Power Button

This button is used for powering the LUNA device. In Standby mode the RGB LED indicator around the button has an orange color. After pressing the button, the RGB LED will blink in orange until the device while the device is booting or starting up. The RGB LED will turn blue when the device is fully operational. Press and hold the button for 3 seconds for safe shutdown. Press and hold the button for 10 seconds for force shutdown.

2.8" LCD Display and Rotary Function Dial

The 2.8" LCD panel and the rotary function dial provide an overview and basic configuration of the system. Navigation through the menus can be done by turning the rotary dial, and pressing it.

USB Host

The LUNA series has two USB Type-C connections, one on the front and one on the rear. These ports can be used for uploading files (e.g. voice messages) or to use a connected device as external storage.

Overview rear panel

The rear of the LUNA series offers various options which are necessary to provide audio I/O and overall control in the desired scenario.

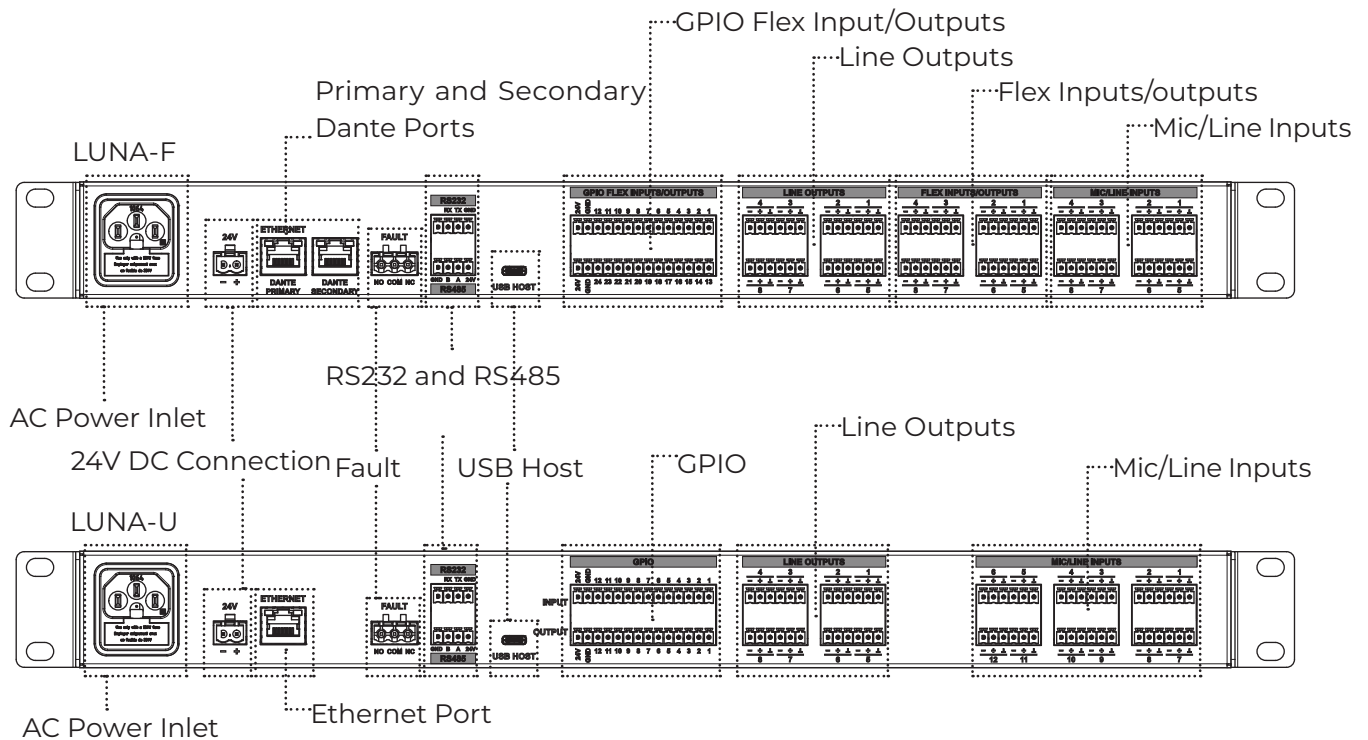

Rear panel description

Mic/Line Inputs

LUNA-F contains eight balanced microphone / line inputs with phantom power possibility with input filter, WaveTune™, and anti-feedback signal processing functions whereas LUNA-U contains twelve balanced microphone and line inputs with the same features.

Flex Inputs/Outputs

LUNA-F has eight flex inputs/outputs which can be either used as mic/line level balanced input with phantom power possibility or balanced output. Flex inputs and outputs have the same signal processing functions as normal inputs and outputs.

Line Outputs

LUNA series both contain eight balanced line outputs with output filter, WavePreset™, delay, and antiphase signal processing functions.

GPIO

LUNA-F has 24 flex inputs/outputs which can be configured in all possible ways. On the other hand, LUNA-U has fixed 12 GPI and 12 GPO ports. LUNA series GPIO ports are not only edge but also configurable threshold level triggered. Input possibilities are active low/high, positive/negative edge, and analogue input 0-33V. Output is open drain.

USB Host

The LUNA series has two USB Type-C, one on the front and one on the rear. These ports can be used for uploading files (e.g. voice messages) as a source for OS Inputs or to use the connected device as external storage.

RS232 and RS485

RS232 and RS485 ports can be used for 3rd party integration communication protocol using commands.

Fault

This relay is triggered when the power supply fails. Fault relay can be used as an indicator for 3rd party devices that the LUNA is integrated into.

Primary and Secondary Dante Ports (only LUNA-F)

The LUNA-F can establish a redundant Dante™/AES67 system through its primary and secondary Dante™ ports. In a non-redundant system, in split mode, the primary Dante™ port is used for Dante data flow, while the secondary Dante port can be used to control the system. In switched mode, multiple devices can be connected together as daisy chain. The LUNA-F comes with 16x16 Dante™/AES67 channels and can be expanded with additional software extension SL-NAC8 for additional networked audio channels. The LUNA-F is limited to a maximum of 64x64 channels.

Ethernet Port (only LUNA-U)

Out of the box, the LUNA-U has an Ethernet port that can only be used for control and configuration. The ANM88 is a hardware extension card that makes a LUNA-U audio matrix processor a Dante™/AES67 enabled device. It comes with 8x8 Dante™/AES67 channels and can be expanded with additional software extension SL-NAC8 for additional networked audio channels. The LUNA-U is limited to a maximum of 32x32 channels. The ANM88 can be integrated into the LUNA-U by simply disassembling the top cover of the audio processor.

24V DC Connection

A 24 Volts DC emergency power supply can be connected to this 2-pin terminal block connector for keeping the LUNA series running on emergency power when the mains power is shut down.

Switch Mode Power Supply

The main power supply (110~240V AC / 50~60 Hz) has to be applied to this AC power inlet. The connection is made by an IEC power connector and is fitted with a fuse. When replacing the fuse, make sure that the value of the replacement fuse matches the value of the original fuse. (T1AL/250V)

Chapter 3



User interface and configuration

This chapter guides you through the user interface and the configuration process of the LUNA series. The 2.8" LCD panel and the rotary function dial provide an overview and basic configuration of the system. For overall design, management, and control of the system, we offer Audac Touch™.

Input and output overview on front panel

Home screen

The home screen of the LUNA series indicates if there is a signal or clipping on analogue inputs or outputs (or on flex input and outputs of LUNA-F). This screen also shows the time, date, and installed project name. Clicking on the rotary function dial shows the menu for connections, devices, and settings. The device returns to the home screen if there is no activity for 10 seconds.

Connections

You can scroll to the right for inputs, flex (LUNA-F only), outputs, and GPIO status screen and return to the main menu. In addition to signal and clipping information, it is also possible to see if any of the inputs are microphone or line level, if the phantom power is enabled, if the flex channel is selected as input or output, or if GPIO is used as analogue or digital IO.

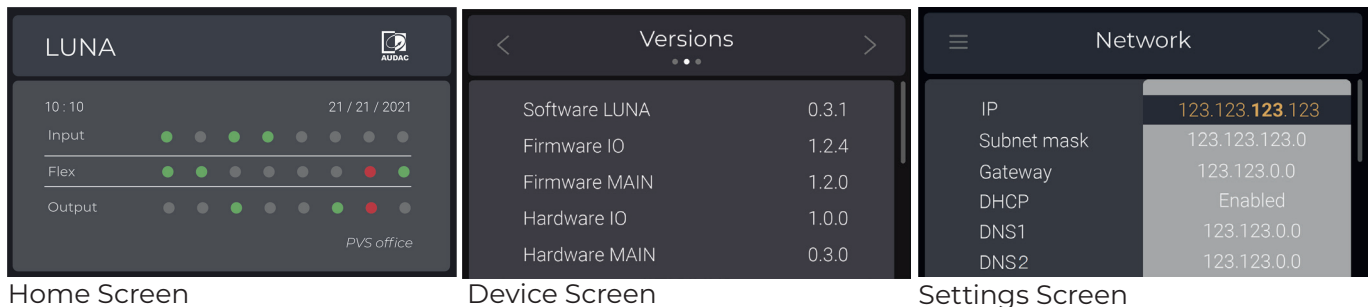

Device

Versions

This section gives version information of software, firmware and hardware of the device. Scrolling right, Update screen shows the running version and availability of new updates.

Update

The update section shows the running version of the device and the updates which are available. Thanks to the OTA feature of the LUNA series, the device automatically checks the latest version whenever the device is on the network. On this screen, the device can be updated to the available software by holding the rotary function dial for 5 seconds.

Settings

Network

IP, DNS, time zone, and time server settings can be changed by clicking the rotary function dial and scrolling down the section. Selection and changing of each parameter can be done by using the rotary dial function intuitively. Scroll down and click Back in order to exit the configuration.

Default settings

Holding the rotary function dial for 5 seconds while in this section will take your device to default settings.

Audac Touch™ 2

Audac Touch™ is our simplified design, management, and system control platform which is on continuous expansion. With this single OS platform, we offer the most intuitive way of designing and managing your installation. From audio processing to sequenced third-party integration. You can also create custom user dashboards without even needing to write a single line of code to offer full system control. AUDAC Touch™ is available for freely downloadable for all major OS.

Login screen

When launching the AUDAC Touch™ 2 application, you have to log-in with your Audac Touch™ credentials. If you don't have an account yet, press the 'Register' button to create a new account.

Device list

Click on the menu icon in the top left corner to have the menu appear. From the menu select "device list". The device list is an overview of all devices which have been discovered (Discovery) and saved (Saved). Every time you start up the AUDAC Touch™, it automatically scans your network for new devices.

Click on one of the devices in the list to open the device's page. The first time a device has opened a password will be prompted. In the case of the LUNA series, the factory default administrator password is 'LUNA'. After entering the correct password the device overview page will be shown with all available I/O channels and zones.

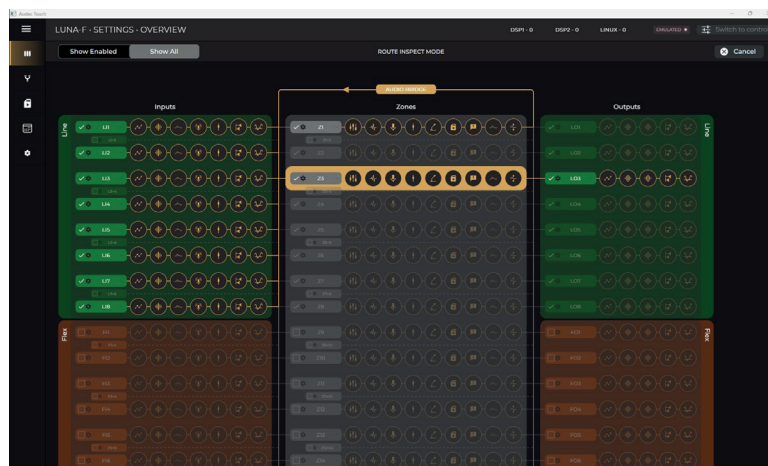

Settings

By clicking the settings button in the top right corner of the devices page the device settings can be changed. The settings for the LUNA series are divided into the following categories: Overview and Device Settings.

Settings >> Overview

The overview page is divided into three blocks: inputs, zones, and outputs. Any of them or the enabled signal processing function of the input, zone, or output channel can be selected for configuration from the overview page. Audio bridge gives a visual understanding of signal mapping with yellow lines by selecting any input, zone, or output on the overview page.

Inputs

The inputs block is the inputs section of the overview page. Available inputs are direct, flex (only LUNA-F), Dante (optional for LUNA-U), OS, and generator.

Gain

Manually adjustable pre-gain for microphone/line level adjustment is available for physical inputs (-6/0/34/40 dB) and gain is available for all input channels with a range of -35 and 35 dB. It is also possible to adjust the input gain automatically.

AGC (Automatic Gain Control)

All inputs contain the possibility to enable Automatic Gain Control (AGC). This continuously adjusts the input gain, ensuring a constant output level while the input level varies. The gain adjustments are made in extremely small step adjustable sizes ensuring high quality audio, even during gain changes.

LP/HP filter

2 band of semi-parametric 2nd order high pass and low pass filters are available on each input channel and can be individually enabled and disabled. Frequency and Q-factor can be adjusted and channels can be enabled individually.

WaveTune™

WaveTune™ is a seven-band full parametric equalizer with dedicated EQ gain that each band can enable individually. This unique function allows fine-tuning of the source signal with different various types of filtering (Peaking, LP, HP, Linkwitz, All Pass, High Shelf, Low Shelf, 1st Order Low Pass, and 1st Order High Pass). This gives the possibility of tailoring the source for optimal performance.

Antifeedback

Antifeedback enables automatic detection of feedbacking frequencies and applies a notch filter to prevent feedbacking.

Volume

Sets the volume of the input source.

Zones

The zones block is the zones section of the overview page. 32 mono or 16 stereo or any configuration in between can be configured here or through the overview page.

Mapping

Maximum 16 channels can be selected from any inputs or zones. That is to say, an already mixed zone can be part of another mix as well. A zone can be mapped into all output channels.

Mixer

The mixer function makes it possible to create a mix of all mapped audio inputs in the selected zone.

Talk over

The talk-over function sets the talk-over source level, and zone level during the talk-over, hold, and fade speed for recovery of the source level.

Volume

Volume has the identical functionality as the master volume of the mixer.

Paging Volume

Sets the volume of the paging announcement in the zone. In addition, the paging console can give an offset to the default paging level. For example, EVAC can be at a higher volume.

Voice file

MP3 and WAV format support from internal and external storage. Voice files can be triggered either by GPIO or Event Handler.

Priority

The priority settings menu makes it possible to configure the priority channels. The LUNA series offers four levels of priority that can be triggered by stereo or mono analog inputs, Flex inputs, Dante inputs and OS inputs.

WaveTune™

WaveTune™ is a seven-band full parametric equalizer with dedicated EQ gain that each band can enable individually. This unique function allows fine-tuning the zone signal with different various types of filtering (Peaking, LP, HP, Linkwitz, All Pass, High Shelf, Low Shelf, 1st Order Low Pass, and 1st Order High Pass). This gives the possibility of tailoring the source for optimal performance.

Compressor/Limiter

A compressor/limiter is an automated volume control tool with the setting of maximum volume to avoid any clipping caused by the signal dynamics or peaks. Threshold and ratio indicate how much the signal is going to be attenuated.

Outputs

The output block is the output section of the overview page. 32 mono or 16 stereo or any configuration can be configured here or through the overview page.

Mapping

Only one of the available zones can be mapped to an available physical or Dante output or OS output.

Gain

The output signal gain can be adjusted manually within a range of -35 dB and +35 dB.

LP/HP filter

2 band of semi-parametric 2nd order high pass and low pass filter are available on each input channel and can be individually enabled and disabled. Frequency and Q-factor can be adjusted and channels can be enabled individually.

WavePreset™

WavePreset™ is a twelve-band full parametric equalizer with dedicated EQ gain that each band can enable individually. This unique function allows fine-tuning the source signal with different various types of filtering (Peaking, LP, HP, Linkwitz, All Pass, High Shelf, Low Shelf, 1st Order Low Pass, and 1st Order High Pass).

Delay

The delay which can be adjusted in steps of 1ms in a range between 0ms to 2000ms (2s) can be enabled on all outputs of the LUNA series. It can be adjusted by moving the corresponding fader up and down. The delay time is indicated in milliseconds on top of the fader and the audio transmission distance in meters is shown accordingly with the delay time. Please note that the meter indication is in average conditions at an air temperature of 21°C.

Settings >> Device Setting

Device/Zone name

The device name can be configured here. The device name can be any kind of freely selectable name. It is also the name that is visible in the Dante controller.

Antiphase

Using the Antiphase option, the output signal rotates over 180° for applications where a contrary phase is desirable.

Updating the system

The update section on the front overview screen shows the running version of the device and the updates which are available. Thanks to OTA feature of the LUNA series, the device automatically checks the latest version whenever the device is on the network. On this screen, the device can be updated to available software by holding the rotary function dial for 5 seconds.

Technical specifications



		LUNA-F	LUNA-U
Input	Mic/Line inputs	8	12
	Flex inputs/outputs	8	No
	GPIO inputs	24 (flex)	12(in)
	USB inputs (Type-C)	Front (file transfer) Rear (file transfer)	
External storage for messages			
Outputs	Line outputs	8	
	GPIO Outputs	24 (flex)	12(out)
Fault		NO & NC relay contact	
Network audio I/O	16x16 Dante™/AES67 I/O Channels (Up to 64x64 Channels with SL-NAC8)		Optional Dante™/AES67 (Up to 32x32 Channels with ANM88 and SL-NAC8)
	Zones	32 Mono 16 Stereo	
Configurable settings	ALC (Automatic Gain control)	Yes	
	AEC (Acoustic Echo cancellation)	Yes (optional)	No
	Integrated event scheduler	Yes	
	Phantom power on inputs	+48 V DC	
	WaveTune (input & zone)	7-band EQ	
	WavePreset (output)	12xBiquad +LP+HP	
	Delay (output)	2000 ms	
	Mono / stereo zones (configurable)	Yes	
	Mixing	Yes	
	Talkover	Yes	
	Paging	Yes	
	Priorities	4 each zone	
	Integrated generator	Sine or Pink noise or White noise	
	Output Volume offset	Yes	
	Others	Antiphase, bass & treble, input volume, ...	
DSP Processor	Dual core SHARC		
	ARM Linux core		
		2 Dedicated co-DSP	No
Configuration	Audac Touch™		
Controls & indicators	Front panel	2.8" LCD Display with rotary encoder	
	Interface ports	RS-232	
		RS-485	
		2 x Gigabit Ethernet (RJ45 primary & secondary)	Gigabit Ethernet (RJ45 primary)
Power supply	100 ~ 240 V AC / 50 ~ 60 Hz		
	24 V DC		
Dimensions	(W x H x D)	482 x 44 x 335 mm	
Mounting	19"		
Unit height	1 HE		
Construction	Steel		
Colours	Black (RAL9005)		

Audio characteristics



		LUNA-F	LUNA-U
Phantom power		+48VDC, on analog inputs and flex channels	
Frequency response	Analog input to analog output	20Hz to 22KHz with +13dBV (15,2dBu) input signal: -0,8/+0,2dB	
THD+N	Analog input to analog output @ 1KHz	< 0,01% @ +22dBV (+24,2dBu)	
		< 0,01% @ +12dBV (+14,2dBu)	
		< 0,005% @ +0dBV (+2,2dBu)	
		< 0,01% @ -12dBV (-9,8dBu)	
		< 0,01% @ -36dBV (-33,8dBu)	
Crosstalk on analog channels	Input to input	> 105dB typical, 95dB max	
	Output to output	> 120dB	
	Flex out to Flex in	> 110dB	
Input dynamic range		103dB @ +22dBV (+24,2dBu) sensitivity	
		103dB @ +13dBV (+15,2dBu) sensitivity	
Input common mode rejection ratio		@ +22dBV (+24,2dBu) sensitivity: 60dB	
		@ +13dBV (+15,2dBu) sensitivity: 60dB	
Input sensitivity		+22dBV (+24,2dBu), adjustable with 0,5dB steps	
Impedance	Balanced input	8k Ω	
	Balanced output	50 Ω	
A/D - D/A converters		32-bit	
Sample rate		48kHz	



Discover more on audac.eu