

# MFA208/216

## User Manual



[www.audac.eu](http://www.audac.eu)

#### ADDITIONAL INFORMATION

This manual is put together with much care, and is as complete as could be on the publication date. The functionality of innovative Audac products is continuously improved and updated. Therefore frequent firmware updates of your equipment are automatically downloaded and recommended. To get a detailed and up-to-date explanation of all functions, please check the latest up to date version of the manual which is available on the web page <https://manuals.audac.eu/mfa208> or scan the QR code as shown below.



# Index

<b>Introduction</b>	<b>5</b>
Block diagram	5
<b>Precautions</b>	<b>6</b>
Caution	6
Safety requirements	7
Caution servicing	7
EC Declaration of Conformity	7
Waste of Electrical and Electronic Equipment (WEEE)	7
<b>Chapter 1: Pin connections and connectors</b>	<b>8</b>
Connection standards	8
RS232 / RS485 / TCP/IP	8
Wire up the system	9
<b>Chapter 2: Front &amp; rear panel</b>	<b>10</b>
Front panel overview	10
Front panel description	10
Rear panel overview	11
Rear panel description	11
<b>Chapter 3: User interface &amp; configuration</b>	<b>13</b>
Front panel control	13
Main	14
Module	14
Input selection	14
Settings	15
Inputs	15
Amplifier	15
Line out	19
General settings	20
<b>Chapter 4: Setting up the system</b>	<b>24</b>
<b>Chapter 5: Installing the SourceCon™ module</b>	<b>26</b>
<b>Chapter 6: Additional information</b>	<b>29</b>
Technical specifications	29
Notes	31



# Introduction

## Multi-functional SourceCon™ Amplifiers

The MFA series are multi-functional SourceCon™ amplifiers, offering true all-in-one solutions for countless applications, ranging from small bars & restaurants to medium sized retail stores, corporate installations, sports facilities and many more. The integrated two-channel amplifier can be used in low impedance stereo systems while bridging merges the output power to be used in constant voltage 70V/100V distributed audio systems.

This combined with the integrated SourceCon™ module offers the most compact and versatile audio system including audio source, processing, matrix system and amplification in a single and compact housing.

The amplifier is designed as a two-channel amplifier using class D amplifier technology. It can be used for powering low impedance stereo systems while bridging to a constant voltage (100V and 70V) public address system is also possible. A switch mode power supply allows a wide variation of mains voltages for global compatibility.

The integrated SourceCon™ module slot enables the implementation of any available compatible module, offering a true all-in-one solution. Typical applications are the implementation of an audio streaming module or internet radio module.

Additionally, a stereo line input allows connection for any kind of external audio sources. A balanced mic/line input allows connection for an announcement microphone or balanced line level signal with compatibility for condenser microphones using the integrated phantom power supply (15V). A priority switch overrides the background music when enabled and compatibility with line-level sources (e.g. voice file players) is guaranteed by wide gain adjustment (0 dB ~ +50 dB).

Thanks to the 2.8" LCD display and the push rotary dial on its front, an unmatched user experience is achieved.

The MFA series are both RS232, RS485 and TCP/IP controllable allowing implementation with home & industrial automation systems and peripheral devices. Using the freely available AUDAC Touch™ 2 application, control and configuration can be done from any portable or non-portable device on any location and at any time.

Desktop installation or mounting in an equipment rack using the MBS3xx series mounting adapters is possible. The half 19" rackspace enclosure allows single installation in a 10.5" equipment rack, or side-by-side (two devices) in a 19" equipment rack

## Block diagram

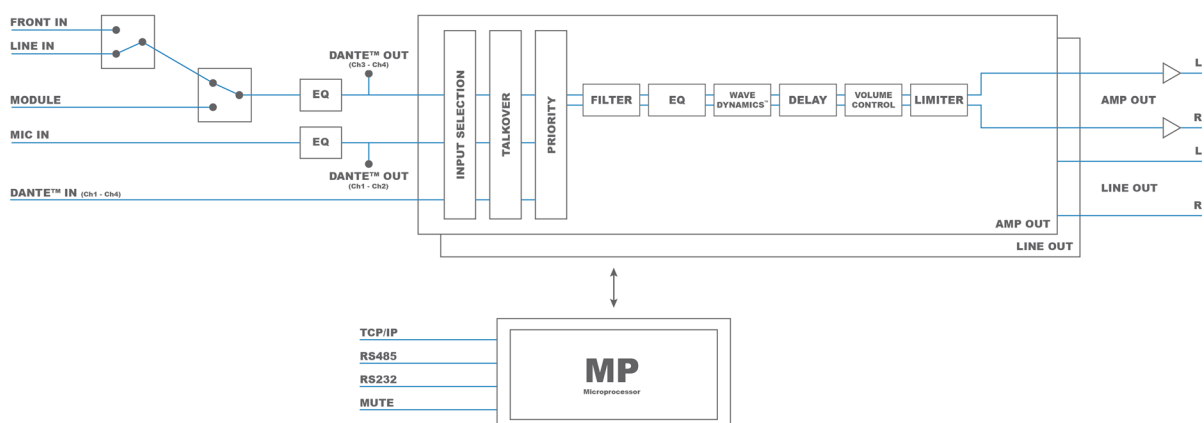

# Precautions

## READ FOLLOWING INSTRUCTIONS FOR YOUR OWN SAFETY

ALWAYS KEEP THESE INSTRUCTIONS. NEVER THROW THEM AWAY

ALWAYS HANDLE THIS UNIT WITH CARE

HEED ALL WARNINGS

FOLLOW ALL INSTRUCTIONS

NEVER EXPOSE THIS EQUIPMENT TO RAIN, MOISTURE, ANY DRIPPING OR SPLASHING LIQUID. AND NEVER PLACE AN OBJECT FILLED WITH LIQUID ON TOP OF THIS DEVICE

NO NAKED FLAME SOURCES, SUCH AS LIGHTED CANDLES, SHOULD BE PLACED ON THE APPARATUS

DO NOT PLACE THIS UNIT IN AN ENCLOSED ENVIRONMENT SUCH AS A BOOKSHELF OR CLOSET. ENSURE THERE IS ADEQUATE VENTILATION TO COOL THE UNIT. DO NOT BLOCK THE VENTILATION OPENINGS.

DO NOT STICK ANY OBJECTS THROUGH THE VENTILATION OPENINGS.

DO NOT INSTALL THIS UNIT NEAR ANY HEAT SOURCES SUCH AS RADIATORS OR OTHER APPARATUS THAT PRODUCE HEAT

DO NOT PLACE THIS UNIT IN ENVIRONMENTS WHICH CONTAIN HIGH LEVELS OF DUST, HEAT, MOISTURE OR VIBRATION

THIS UNIT IS DEVELOPED FOR INDOOR USE ONLY. DO NOT USE IT OUTDOORS

PLACE THE UNIT ON A STABLE BASE OR MOUNT IT IN A STABLE RACK

ONLY USE ATTACHMENTS & ACCESSORIES SPECIFIED BY THE MANUFACTURER

UNPLUG THIS APPARATUS DURING LIGHTNING STORMS OR WHEN UNUSED FOR LONG PERIODS OF TIME

ONLY CONNECT THIS UNIT TO A MAINS SOCKET OUTLET WITH PROTECTIVE EARTHING CONNECTION

THE MAINS PLUG OR APPLIANCE COUPLER IS USED AS THE DISCONNECT DEVICE, SO THE DISCONNECT DEVICE SHALL BE READILY OPERABLE

USE THE APPARATUS ONLY IN MODERATE CLIMATES

## CAUTION

The symbols shown are internationally recognized symbols that warn about potential hazards of electrical products. The lightning flash with arrow point in an equilateral triangle means that the unit contains dangerous voltages. The exclamation point in an equilateral triangle indicates that it is necessary for the user to refer to the users manual.



These symbols warn that there are no user serviceable parts inside the unit. Do not open the unit. Do not attempt to service the unit yourself. Refer all servicing to qualified personnel. Opening the chassis for any reason will void the manufacturer's warranty. Do not get the unit wet. If liquid is spilled on the unit, shut it off immediately and take it to a dealer for service. Disconnect the unit during storms to prevent damage.



### CAUTION – SERVICING

This product contains no user serviceable parts. Refer all servicing to qualified service personnel. Do not perform any servicing (unless you are qualified to)



### EC DECLARATION OF CONFORMITY

This product conforms to all the essential requirements and further relevant specifications described in following directives: 2014/30/EU (EMC) and 2014/35/EU (LVD)



### WASTE ELECTRICAL AND ELECTRONIC EQUIPMENT (WEEE)

The WEEE marking indicates that this product should not be disposed with regular household waste at the end of its life cycle. This regulation is created to prevent any possible harm to the environment or human health.

This product is developed and manufactured with high quality materials and components which can be recycled and/or reused. Please dispose this product at your local collection point or recycling centre for electrical and electronic waste. This will make sure that it will be recycled in an environmentally friendly manner, and will help to protect the environment in which we all live.

## POWER SUPPLY AND POWER CORD REQUIREMENTS

### Power supply class I grounding requirements:

For protection from fault currents, the equipment shall be connected to a grounding terminal. Plug the system power cord into an AC outlet that provides a ground connection. Substitute cords may not provide adequate fault protection. Only use the power cord supplied with this product or an authorized/equivalent replacement

### Safety notices:

#### Denmark:

Apparatets stikprop skal tilsluttes en stikkontakt med jord, som giver forbindelse til stikproppens jord.

#### Finland:

Laite on liitettävä suojakoskettimilla varustettuun pistorasiaan.

#### Norway:

Apparatet må tilkoples jordet stikkontakt.

#### Sweden:

Apparaten skall anslutas till jordat uttag.

## COOLING & VENTILATION

The MFA2xx series amplifiers are relying on convection cooling to keep the maintenance low and eliminate any production of ambient noise. The convection cooling system can only work properly when all ventilation openings are not blocked and accessible, allowing free and natural air flow through the unit.

When using in a tabletop setup, the bottom of the housing shall keep distance from surface (table, shelf, ... ) through the mounted feet underneath to let air reach the ventilation openings on the bottom of the housing. The top side ventilation slots shall also remain open with sufficient clearance above the unit.

When installed (multiple) unit(s) in an equipment rack housing, at least one free rack space shall remain blank on top and bottom of the unit, remaining sufficient clearance for guaranteeing a proper air circulation throughout the unit.

# Chapter 1

## Pin connections and connectors

### CONNECTION STANDARDS

The in- and output connections for AUDAC audio equipment are performed corresponding to international wiring standards for professional audio equipment.

#### Cinch (RCA):

For unbalanced line input connections.

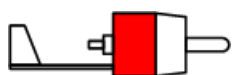

**Tip:** Signal  
**White:** Left

**Sleeve:** Ground  
**Red:** Right

#### 3-Pin Terminal block:

For balanced signal input connections

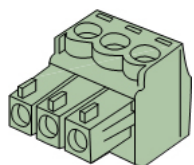

**Left:** Signal – (XLR Pin 3)  
**Center:** Signal + (XLR Pin 2)  
**Right:** Ground (XLR Pin 1)

For balanced signal input connections

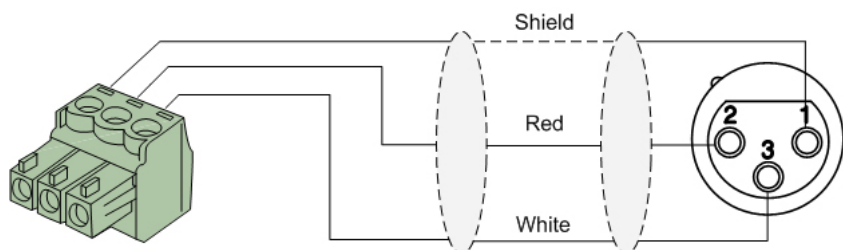

For unbalanced signal input connections

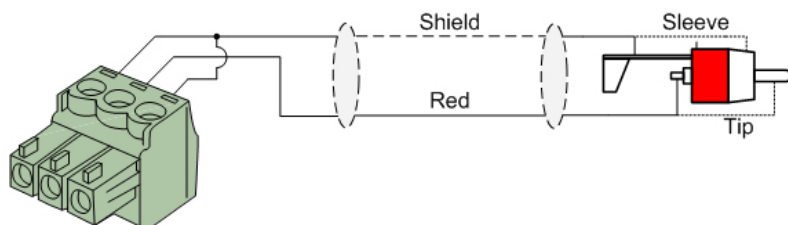

### RS232 / RS485 / TCP/IP

The MFA has RS232, RS485 and TCP/IP ports which all accept the same commands. The complete command set to control the MFA is available in the MFA commands user manual which is freely downloadable on <https://manuals.audac.eu/mfa208>



## RS232/RS485 serial connection interface

For connection with home automation systems or other remote control equipment

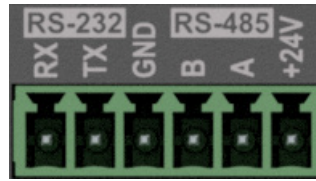

**Connection** Standard RS232/RS485

**PIN 1 (left)** RS232 – MFA RX  
**PIN 2** RS232 – MFA TX  
**PIN 3** GND  
**PIN 4** RS485 – MFA B  
**PIN 5** RS485 – MFA A  
**PIN 6 (right)** +24 V DC

**Settings** 19200 Baud  
8 Bit  
1 Stop bit  
No parity  
No handshaking

### Ethernet device port numbers:

Description	Protocol	Addressing	Port number
Announce, device discovery	UDP	Broadcast	30303
Webinterface	TCP	Unicast	80
Control	TCP	Unicast	5001
IP settings	TCP	Unicast	5001
Web update (TFTP)	UDP	Unicast	TBD
NTP Timeserver	UDP	Unicast	123

## Wire up the system

The wiring of the system must be done according to the following rules, to guarantee a proper functioning of the system in all circumstances.

1. RS-232/RS-485 connections & wall control panels  
UTP/FTP Cat5e cable or better
2. Speaker cable for amplified zone outputs:  
*Minimum 2 x 1.5 mm<sup>2</sup>*  
*If distance > 15 m: 2 x 2.5 mm<sup>2</sup>*
3. Music sources and other in & outputs  
*Must be connected with high-quality audio cable and connectors*
4. Ethernet connection:  
*UTP/FTP Cat5e cable or better*

# Chapter 2

## Front & rear panel

### Front panel overview

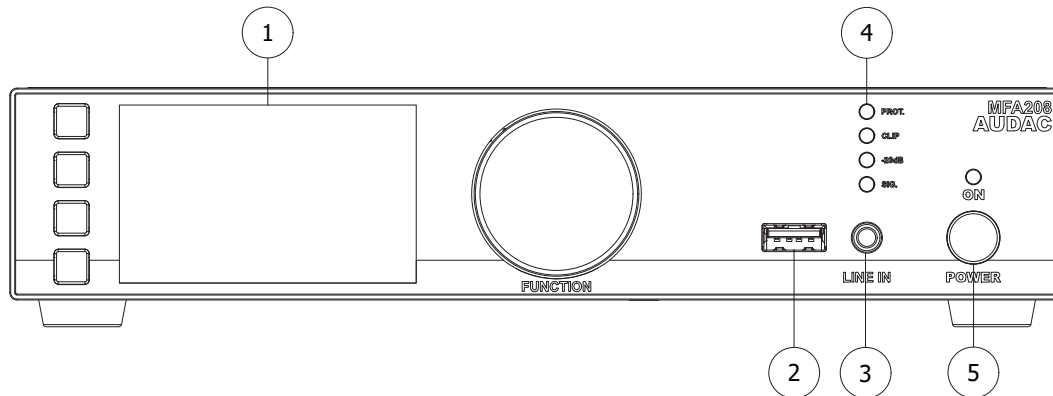

### Front panel description

#### 1) Display with tactile push buttons and rotary selection dial:

A clear system overview and intuitive user experience is offered using the 2.8" graphical LCD display accompanied with four tactile selection buttons (left side) and a rotary selection dial (right side). The color display offers a clear overview of the system's current operation mode with intuitive and user-friendly menu navigation.

The functionality of the four push buttons depends on the current operation mode and position in the menu structure. In the main menu, the upper one allows access to the module functions, while the second and third gives you access to volume settings (amplifier and line out). The lower one redirects you to the settings menu. This will be further explained in chapter 3.

In other menu's, corresponding icons are shown on the left side of the display. Parameter adjustment and browsing are made easy using the rotary function dial. This multifunctional dial allows easy one-hand operation throughout the entire menu structure. Browsing through the menu is done by rotating it while actions are made by pressing it.

#### 2) USB slot:

The USB slot is internally connected with the module slot and can be used for data storage, media playback or any other supported functions (if supported by the module). Additionally, the USB connection can be used for firmware updates to the system.

#### 3) 3.5 mm jack input:

The 3.5 mm jack input is an unbalanced stereo line input whereto any (portable) device such as laptop, smartphone or tablet with 3.5 mm jack audio output can be connected. This input is combined with the line input on the rear amplifier side (RCA), meaning the rear side input is disabled when the front 3.5 mm jack is connected.

#### 4) Indicator LED (VU):

The (VU) indicator leds indicate the output level and status of the amplifier (Signal / -20 dB / Clip / Protect).

#### 5) Power button:

Allows to switch the system between ON and Standby. The indicator LED illuminates in orange color when in standby and illuminates in blue when switched on. When powering on, it takes about 10 seconds before the amplifier is switched on and fully operational.

# Rear panel overview

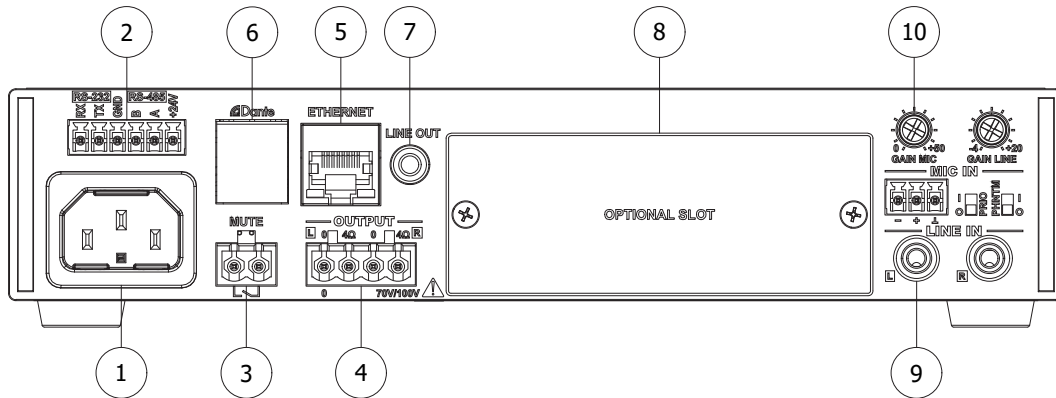

## Rear panel description

### 1) AC Power inlet:

The mains power supply (100–240V AC – 50/60 Hz) has to be applied to this AC power inlet. The connection is made by an IEC C14 power connector.

### 2) RS232 / RS485 connector:

The RS232 and RS485 connectors allow integration of the MFA in an automation system. This interface can also be used for connection of optional wall panels (MWX45).

### 3) Priority mute contact:

A priority mute contact mutes the amplified output at the presence of a contact closure between both terminals. Priority enabled on MIC IN overrides the muting, allowing emergency announcements or voice messages. This is a Normal Open (NO) contact, which means priority muting is enabled when the contact is closed.

### 4) Loudspeaker output connections:

Output connections for both stereo low impedance and mono constant voltage distributed audio systems are implemented using a 4–pin terminal block connection. More information about loudspeaker output connections is described in the ‘connecting the system’ chapter.

### 5) Ethernet RJ45 Connector:

The MFA is connected to an Ethernet network through this connection. It allows control of the system and its installed modules from any Ethernet supported device. Various possibilities of Ethernet control are available, including sending commands over TCP/IP and full system control using the AUDAC Touch™ 2 application.

### 6) Dante® module connection (optional):

The MFA amplifier can be expanded with an optional ANI44 DANTE module. Using this module, bi–directional network based audio transfer using the Dante® protocol is made possible. The direct inputs (microphone and line or SourceCon™ module input) are also transmitted over Dante®, allowing to receive these inputs on other Dante® compatible devices in your network as well. The line / SourceCon™ module inputs are linked with Dante channels 3&4 (stereo) while microphone in is linked with Dante channels 1+2 (mono). (See block diagram)

### 7) Line out:

An unbalanced line–level output is available. This output is configurable as a pre–amp output (following the same source and volume as the internal amplifier) or as a secondary zone output (with individual input selection and volume regulation). When configured as a secondary zone output, a two zone system can be achieved. When configured as a secondary zone output, only the same selection between line and SourceCon™ module can be made as on the primary (amplified) output (see block diagram for clarification). Other inputs (e.g. Dante®) are free to be chosen.

### **8) SourceCon™ interface card slots:**

A modular slot allows installation for a wide variety of optional SourceCon™ modules depending on the required system functionality. The module slot is fitted with a guiding system and connection is made by board–edge connectors allowing fast and simple installation.

### **9) Unbalanced stereo line input:**

An unbalanced line–level input source (e.g. media–players, radio tuners, ...) can be connected to the line input which is implemented through RCA connectors. A gain control potentiometer adjusts the sensitivity within a range of  $-4\text{ dB} \sim +20\text{ dB}$ .

#### **NOTE**

The gain control potentiometer for the line input on the rear also affects the level for the 3.5 mm jack input connection on front. When switching between front and rear input, it is recommended to configure both connected audio sources with equal output levels to allow easy switching (without adjusting the rear input gain).

### **10) Balanced microphone input:**

Balanced mono sources can be connected to the microphone input which is implemented using a terminal block connector. A gain control potentiometer adjusts the sensitivity within a range of  $0\text{ dB} \sim 50\text{ dB}$  which allows connection for both microphone or line–level audio sources.

A phantom power switch enables 15 Volts phantom power supply for powering condenser microphones and a priority switch eliminates other connected audio sources once a signal is present on this input. When priority is enabled, this input has overall priority over all other inputs and also overrides the priority mute. More configurations options regarding priorities can be made through software configuring.

### **Compact half 19" rack space enclosure:**

The MFA amplifiers are housed in a compact half 19" rack space enclosure which can be used for desktop installation or mounted in an equipment rack using (optionally available) mounting adapters. The half 19" rack space enclosure allows single installation in a 10.5" equipment rack or side–by–side (two devices) in a 19" equipment rack. Combinations with other amplifiers with the same form factor are also possible.

# Chapter 3

## User interface & configuration

The MFA2xx contains a variety of control and configuration possibilities. The front panel of the unit is fitted with a 2.8" graphical LCD display, allowing instant control and configuration possibilities through an intuitive and user-friendly user interface.

Remote control of the system is possible through the AUDAC Touch™ 2 application. This fully adaptive interface can be accessed from almost any device, offering cross-platform compatibility with Windows, Linux, Mac, Android, and iOS. The fully adaptive structure guarantees a clear viewing on all different kinds of screen sizes. This Audac Touch™ 2 application allows you to custom configure your control panel (Dashboard) according to project or user-specific requirements.

For using the AUDAC Touch™ 2 interface, the MFA shall be connected to an Ethernet LAN network and accessed by its IP address. In factory default configuration, the MFA network settings are DHCP enabled, meaning the IP address will be automatically assigned by the DHCP server in your network. In case a specific fixed IP address is required, it can be configured in the network settings menu of the MFA.

### Front panel control

The front panel allows control for the functions of the MFA itself and for the installed SourceCon™ module. The MFA settings include amplifier settings, in & output settings, general settings and many more. The controllable functions of the SourceCon™ module are strongly depending on the installed module. Therefore, it is not possible to describe the menu structure possibilities for each individual module in detail. An overview of how the entire menu is constructed and how to navigate through it is given here.

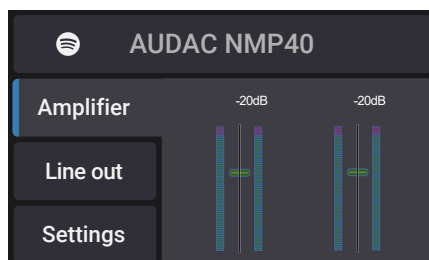

The front panel of the device includes a 2.8" graphical LCD display, which is accompanied by four tactile push buttons (left side) and a rotary selection dial (right side). This combination allows you to navigate through the systems user interface and access all the available control and configuration possibilities of the system. The functionality of the four tactile push buttons on the left side depends on the current mode and position in the menu structure.

In the main menu, the upper button offers access to the SourceCon™ module slot allowing to enter their specific menu and offering access to its further functions. The second and third gives you access to volume settings (amplifier and line out). The lower one redirects you to the settings menu.

In the control menus (not configuration) there will always be 4 icons shown on the left side of the display which functionalities are linked with the corresponding buttons. The rotary selection dial can be used for parameter adjustments and browsing to station lists, playlists or any other. This multifunctional dial allows easy one-hand operation throughout the entire menu structure. Browsing is done by rotating it while actions are made by pressing it.

The lower one of the four tactile push buttons is always assigned to go one step back and undo unsaved changes to settings in the menu structure, in case there is no other function assigned to it.

## Front control > Main

The main screen gives an indication of the operation mode of installed module on the top. When a module is installed, an icon will indicate the function of the module. In case no module installed, the provided area will display the amplifier model. When installed and playing, the information regarding the station, track, tuning frequency or any other carried information will be indicated here.

Below is a fader overview given indicating the output level through VU bar graphs and volume faders, whereby the output volumes can get adjusted.

In default configuration, the MFA is configured as a two zone system, indicating two output volume faders. (one for the internal amplifier and a second one for the line out connection). In case only one output is being used (e.g. internal amplifier) the secondary volume fader can be hidden through adjusting the linking settings. (Settings > Line out > Output > Link input & Link volume). In this situation, the 'Line out' will be greyed-out.

The selection between both outputs is done through the 'Amplifier' and 'Line out' buttons on left screen side and volume adjustments are made through turning the rotary function dial clockwise (up) and counter-clockwise (down). The output level can be adjusted within a range of 0 dB and -90 dB.

The currently selected input, set output level and a mute indicator (red / green) is shown on top of each fader.

## Front control > Module

When module control is being selected, the corresponding menu will be loaded. The available functions and composition of this screen fully depend on the installed module and its functionality. For a full overview of the available settings for the corresponding module, consult the instruction manual of the installed module itself.

## Front control > Input selection

The input signal linked to each of the outputs is configured in the input selection menu. This menu is accessible by pressing the rotary selection dial in the main screen. When pressed, a list indicating all available inputs will be shown and the required input can be selected. It includes the microphone input, line input, internal SourceCon™ module input and all available Dante channels (in case an optional Dante module is installed).

A system limitation is that both Line and the SourceCon™ module input are sharing the same internal channel. This results in the inability to route the line and module to separate outputs at the same time. For all other inputs (microphone, Dante, ... there is no such restriction...). This is clearly indicated in the system block diagram which can be found on page 5 of this manual.

# Front control > Settings

The settings menu is accessed through pressing the settings (lower) button on the main screen. This menu includes all the settings regarding the inputs, amplifier output, line output and general system settings. Specific settings regarding the installed modules are found in the module control menu.

## Front control > Settings > Inputs

The input settings menu includes a 7-band parametric equalizer for both microphone and line (Line / module) inputs. It allows to cut or boost specific frequency ranges.

A standard configuration with center frequencies for 60 Hz, 150 Hz, 400 Hz, 1 kHz, 2.6 kHz, 6.8 kHz and 15 kHz with Q factor of 0.7 is pre-loaded. The center frequency of each band can be continuously adjusted within a range of 10 Hz and 22 kHz, while the Q-factor can be adjusted within a range of 0.1 and 9.9 and the level of each band within a range of +15 dB and -15 dB.

A fader overview for the 7 bands equalizer will be shown when selecting the corresponding input. On top of the screen, the center frequencies for each band are shown on top of the currently set levels. The selection of the corresponding band is done by turning the rotary selection dial until the corresponding band is highlighted and pressing it. Level adjustment can be done by turning the selection dial and confirmed by pressing it again. After this confirmation, another band can be selected and adjusted the same way.

Adjustment of the center frequencies and Q-factors is done through pressing the 'Freq' and 'Q' buttons on the side. When selected, a pop-up window will appear where the corresponding adjustments for each band can be made. Adjustment of center frequencies is done by selecting the adjusting digit (highlighted) and confirming. The value will increase or decrease through rotating the rotary selection dial. Consecutive digits will increase when the maximum value is reached. After the desired frequency has been selected it can be confirmed by pressing and turning the function dial clockwise until 'OK' is highlighted.

Q-factors are changed by selecting and turning clockwise (up) or counter-clockwise (down). This confirmation can be done by pressing again.

## Front control > Settings > Amplifier

The amplifier settings menu leads you to a separate menu where the settings for the amplified output can be made.

### Front control > Settings > Amplifier > Mute:

Muting will completely suppress the output signal. The mute indicator will indicate in green when the channel is playing and turns red when muted. Toggling between both states can be done by pressing the rotary function dial once.

### Front control > Settings > Amplifier > Filter:

Filters are frequently used in audio systems for different purposes. Some typical application examples are filtering noise or other unwanted signals from an audio signal and separating audio signals between different frequency ranges (crossover) when a 2-way (or more) system is used.

Because the characteristics of the required filter are strongly dependent of the application, the filter settings are made flexible and user configurable. Characteristics which can be configured for the filters are:

<b>Type:</b>	Selectable between Disabled, Butterworth, Bessel, Linkwitz–Riley
<b>LP/HP:</b>	Lowpass / Highpass
<b>Roll–off:</b>	Selectable between 12 dB/Oct and 24 dB/Oct
<b>Frequency:</b>	Infinitely adjustable between 10 Hz and 20 kHz

The configuration of the desired filter is made through selecting the required filter type and characteristics. Toggling between various characteristics is done by pressing the rotary dial in case two options are available (LP/HP and Roll–off) while the filter type selection is done by rotating and confirming by pressing the rotary dial. When adjusting the frequency, a 5 digit number is shown and the adjusting digit can be selected (highlighted) and confirmed by turning and pressing the rotary selection dial. Consecutive digits will increase when the maximum value has been reached. After the desired frequency has been selected it can be confirmed by highlighting and pressing the word 'OK'. After pressing again the frequency is confirmed and the next characteristic can be adjusted. If all characteristics are set to the required value, select the 'Save' option and you will be returned to the output setup menu.

### **Front control > Settings > Amplifier > EQ Setup:**

The EQ setup menu includes a 7–band parametric equalizer for the amplified output of the MFA. Operating this equalizer is identical with the equalizer function on the inputs of the amplifier, so refer to the inputs section of this manual for a detailed description on how.

### **Front control > Settings > Amplifier > Output:**

The output menu includes all the configuration settings which can be configured for the amplified output of the amplifier.

### **Front control > Settings > Amplifier > Output > Delay:**

The delay function allows to enable a specific delay between the input and output signal, which can be used for time alignment between different loudspeakers in one configuration. It is configurable in meters within a range of 0 meter and 12 meter with a resolution of 0.1 meter / step. Adjustments are done by selecting it and turning the rotary selection dial. After the required delay is selected, it is confirmed by pressing the dial.

### **Front control > Settings > Amplifier > Output > Max level:**

The Max level function guarantees the output level to never exceed a certain value. This protects the system from users increasing the output volume over a pre–defined value. It can be adjusted within a range of 0 dB (no restrictions) and –70 dB. Adjustments are made through selecting by pressing the rotary button, while the set value is changed through rotating. Press again to set select the currently selected value.

### **Front control > Settings > Amplifier > Output > Standby:**

The standby mode will switch the amplifier to standby in case no signal is detected for a certain period. The delay time between the absence of a signal and switching to standby mode can be selected in this screen. It can be disabled (never) or adjusted within a range of 1 to 120 minutes. The power consumption of the amplifier will decrease when it is switched to standby. When the amplifier is switched to standby, it takes < 300 ms to wake–up the amplifier and resume audio playback.



### Front control > Settings > Amplifier > Output > Limiter:

The output level can be limited to a certain power. This is very useful when the output power of the amplifier is exceeding the maximum power handling capability of the connected loudspeakers. In case of an increasing level of the applied input signal, the output power will always be limited to the configured value. This way, loudspeaker damage due to power overload can be avoided. The maximum output power is selectable within a range of 10 Watt and the maximum output power of the amplifier, and can be adjusted in steps of 5 Watt.

The currently configured limiter setting is depending on the impedance of the connected loads. Therefore, make sure that the load impedance settings for low impedance outputs are configured correctly between 4 Ohm, 8 Ohm or 16 Ohm. This configuration is made in the 'Output type' setting (the next setting).

### Front control > Settings > Amplifier > Output > Output type:

The output type can be selected between 100V and 70V for constant voltage audio systems and 4 Ohm, 8 Ohm or 16 Ohm for low impedance audio systems. Since the output and limiter settings are configured according to this selected value, it is always very important to make sure that this is correctly configured. Incorrect configuration of this setting can lead to damage of the amplifier or the connected loudspeakers.

### Front control > Settings > Amplifier > Output > Phase reverse:

The phase reverse setting shifts the output signal over a 180 degrees, for applications where reversed phase between input and outputs is desirable.

### Front control > Settings > Amplifier > Output > Clear preset:

Loudspeaker presets can be uploaded to the amplifier. Customized presets can be made, or typical loudspeaker presets can be downloaded and loaded into the amplifier. Every preset is made and optimized for one specific type of loudspeaker. This window indicates if any preset is currently loaded. Presets meant for other than the connected loudspeakers may affect the performance and sound quality in a negative way, while not providing optimal protection.

Clearing the currently loaded preset is done by selecting this option, dialing to clear and pressing it. Note that other configurations for the corresponding channel (Eg. filters, equalizing, ... ) which are separately made from the preset will remain unchanged.

### Front control > Settings > Amplifier > Output > Linking:

Various linking settings (Link input, Link volume and Volume offset) are shown here. These settings allow permanent linking of both amplifier and line output of the MFA. The linking settings have to be made in the output settings menu of the line output, and therefore are not accessible in this menu.

### Front control > Settings > Amplifier > Priority:

The priority menu allows to enable priority functionality on the amplifier output. The priority setting has various configurable settings, such as:

<b>Enable:</b>	Selectable between On / Off
<b>Input:</b>	Selectable between Microphone, Module/Line & Dante inputs (if installed)
<b>Threshold:</b>	Selectable within a range of -40 dB ~ -70 dB (Default= -60 dB)
<b>Level:</b>	Selectable within a range of 0 dB ~ -70 dB (Default= -6 dB)
<b>Attack:</b>	Selectable within a range of 0 and 9999 ms (Default= 100 ms)
<b>Hold:</b>	Selectable within a range of 0 and 9999 ms (Default= 500 ms)
<b>Decay:</b>	Selectable within a range of 0 and 9999 ms (Default= 100 ms)

In case priority is enabled, all playing audio sources will be interrupted upon signal detection on the selected priority input and only the priority input will be heard. The priority settings should be configured depending on the available audio signal.

## Priority exceptions

**MIC IN:** The microphone input connection on the rear side is fitted with a priority switch. When enabled, this input will have overall priority over all other inputs (even when not enabled by software). It uses the priority level and threshold values configured in output settings.

**FMP40:** In case an FMP40 SourceCon™ voice file media player module is installed, the events triggered by this module have overall priority over all inputs. Even when not enabled by software, or the module is not configured as an input.

**Threshold:** The threshold parameter specifies the level when the priority shall be enabled. When the level of the applied input signal exceeds the configured threshold level, the priority will be enabled. The threshold level should be set high enough to avoid accidentally triggering the priority by noise.

**Level:** The level parameter specifies at which output level (volume) the priority message shall be announced. This allows the priority announcement always being heard at a pre-configured level, making sure it is always clearly audible, even when the volume of the amplifier is lowered or completely turned down.

**Attack:** The attack parameter specifies the reaction time with which the amplifier shall switch to priority when a signal above the configured threshold level is detected.

**Hold:** The hold parameter specifies the hold time, how long no action should be taken in case the input signal reaches a level lower than the currently configured threshold level.

**Decay:** The decay parameter specifies the time in which the background music will increase again to the target level after the priority announcement is finished.

## Front control > Settings > General > Talkover:

The talkover menu allows to enable talkover functionality on the amplifier output. This function is very similar with the priority functionality, with the difference that talkover has a ducking parameter instead of a level parameter.

While the priority function completely suppresses all other music sources (totally cuts the background music), the talkover ducks the other music sources, while still having them come through at a certain (configurable) level.

<b>Enable:</b>	Selectable between On / Off
<b>Input:</b>	Selectable between Microphone, Module/Line & Dante inputs (if installed)
<b>Threshold:</b>	Selectable within a range of -40 dB ~ -70 dB (Default= -60 dB)
<b>Ducking:</b>	Selectable within a range of 0 dB ~ -70 dB (Default= -12 dB)
<b>Attack:</b>	Selectable within a range of 0 and 9999 ms (Default= 500 ms)
<b>Hold:</b>	Selectable within a range of 0 and 9999 ms (Default= 500 ms)
<b>Decay:</b>	Selectable within a range of 0 and 9999 ms (Default= 500 ms)

## Mixing

In case mixing between a line and microphone input is required, this can be configured through enabling the talkover functionality while configuring the ducking parameter at 0 dB. This allows both signals come through at identical output levels without losing signal strength.

## Front control > Settings > Amplifier > Wallpanel:

The wall panel menu allows a selection of the available inputs to be configurable though the connected wall panels (MWX45), or the zone widgets when using the AUDAC Touch™ 2 app. It shows 8 input channels ('WP IN 1' up to 'WP IN 8') to which a corresponding input can be assigned. The selected inputs will correspond with the inputs numbers on the wall panel or selection list in the zone widget. All available inputs can be selected, including microphone, line/module and Dante inputs. In case less than 8 inputs are required to be selectable, specific inputs can be disabled by selecting the 'Off' option.

Default input configuration:

- WP IN 1:** Microphone
- WP IN 2:** Line
- WP IN 3:** Module
- WP IN 4:** Dante 1 (optional)
- WP IN 5:** Dante 2 (optional)
- WP IN 6:** Dante 3 (optional)
- WP IN 7:** Dante 4 (optional)
- WP IN 8:** Dante 1+2 Stereo (optional)

## Front control > Settings > Line out:

The line out settings menu leads you to a separate menu where the configurations for the line output connection can be made. This menu includes exactly the same settings as available for the amplified output of the amplifier (except irrelevant settings such as, standby, limiter and output type), with some additional linking settings which have to be configured here. The linking settings are available in the Line out > Output > Linking menu.

The functioning and configuration of the identical settings is described in the previous chapter, while here all additional settings will be explained.

## Front control > Settings > Line out > Output > Linking:

Various linking settings (Link input, Link volume and Volume offset) are shown here. These settings allow permanent linking of both the amplifier and line output of the MFA.

- Link input:** Selectable between On / Off
- Link volume:** Selectable between On / Off
- Volume offset:** Selectable within a range of  $-70$  dB ~  $+ 20$  dB (Default= 0 dB)

**Link input:** When enabled, the input signal for the line output is permanently linked and following the selected input on the amplified output. This is useful in installations where no individual source selection is required for the line output of the amplifier. The input selection menu for the line output is not accessible when the inputs are linked.

### Priority

When the input for both channels is linked with each other and a priority situation occurs on one of both, the priority message will only be heard on the output the priority message is assigned to. The priority message won't be heard on the linked output. In case this is desirable, the priority should be configured to the secondary output independently.

**Link volume:** When enabled, the volume for the line output is permanently linked and continuously following the configured volume on the amplified output. There will be only one volume fader shown on the main screen when the volumes are linked.

**Offset:** The offset parameter allows to configure a fixed difference in output level between the amplified and line output when the volumes are linked. This is useful in situations where both outputs require different levels with a constant correlation. The offset parameter indicates the difference in output level of the line output compared to the amplified output. Positive values indicate a louder level of the line out, while negative values are indicating a lower level of the line out.

## Front control > Settings > General settings:

The general settings menu allows you to configure all the global settings for the MFA Amplifier. Module settings are changed in the module menu. The functionalities of the general settings menu are described as follows:

**Lock:** When selecting 'Lock', the system will be locked and will require a password to be entered before any further action can be taken (the password lock is enabled when a password different from '0000' is configured).

**Info:** Gives an overview of the MFA device, the software version the MFA is running, the type of the installed module and the software version the module is running.

**Display:** Adjustments for the LCD settings can be made here. The brightness can be adjusted within a range of 10% to 100% (standard is 80%). Adjusting the LCD brightness should be done to allow perfect readability of the screen depending on the ambient light of the environment.

The backlight off time can be adjusted within an interval of 5 up to 120 minutes or never (always on), making the backlight of the LCD automatically switch off after the configured time.

**Address:** The address of the MFA can be set here and is selectable within a range of 'F001' up to 'F999'. When multiple units are daisy-chained with each other (e.g. through RS-485 databus), a unique address should be assigned to each connected unit to make them addressable. In factory default configuration, the address 'F001' will be assigned to each device.

**Password:** Protection can be enabled, avoiding unauthorized users to make any adjustment to the system. The lock password is a four-digit code which is default set to '0000', giving full access to the system without requiring any password to be entered. If the configured password is different from '0000', the user will be requested to enter the password before any access to the systems is provided.

The configuration of the selected password can be made by selecting it. The adjusting digit will be highlighted and can be adjusted through rotating the rotary selection dial. Consecutive digits have to be adjusted one by one.

After the desired password is entered it can be confirmed by pressing and turning the function dial clockwise until the OK word is highlighted and pressing the dial. After confirming, the selected password has been set.

The other shown passwords 'Master' and 'User' are passwords required for accessing the MFA through external remote control systems such as the AUDAC Touch™ 2 application. The master password (default = MFA) gives access to all available functions of the device, including administrator level functions such as system settings. The user password (default = user) only gives access to basic functions such as volume changes and input selection. Changing these passwords has to be done through the external remote control systems.

**Network:** When network settings is highlighted, an overview of the currently configured network settings is given on the right screen side. When selected by pressing the dial, a separate IP settings menu will be loaded, where all network settings can be customized.

### DEFAULT NETWORK SETTINGS

DHCP: **ON**

IP address: **Depending on DHCP**

Subnet mask: **255.255.255.0 (Depending on DHCP)**

Gateway: **192.168.0.253 (Depending on DHCP)**

DNS 1: **8.8.4.4 (Depending on DHCP)**

DNS 2: **8.8.8.8 (Depending on DHCP)**

**DHCP:** When DHCP is enabled, the IP address for the MFA is automatically assigned by the DHCP server in your network. When DHCP is enabled (default) the device will always be discoverable and accessible through the other devices in your network.

#### REBOOT

The DHCP assigned IP address can be different after system reboot. This can lead into unknown IP addresses, and improper functioning when used in combination with external remote control equipment over network.

**IP address:** The IP address for the system can be configured in this window. Each section of the IP address can be individually adjusted by turning the rotary dial (clockwise for up, and counter-clockwise for down). The currently adjusting section will be indicated in blue colour. Once the correct number for the current section is selected, proceed to the next section by pressing the rotary dial.

**Network settings:** All other network settings such as subnet mask, Gateway, DNS 1 and DNS 2 can be configured in this window. The default settings are configured in such way to suit most typical installations requirements. In case of special network restrictions or requirements, consult your network administrator for more details on the network settings. All additional network settings can be modified in a similar way as the IP address, allowing adjustments by turning and pressing of the rotary dial.

#### SAVE

Any changes to network settings made in this menu shall be saved by selecting 'Apply settings' through highlighting and pressing it. Otherwise changes made to the settings won't be applied to the system.

#### Front control > Settings > General settings > USB:

USB will lead you to a separate sub-menu where all settings and options using USB functions can be found. A USB flash disk should be inserted to the USB slot on the front of the amplifier and shall be formatted using FAT32 file system.

**Connection:** The menu allows to switch the USB connection on front of the MFA between the module and main MFA system. In its default configuration, it is connected the installed module (only if a supporting module is installed), which offers functionality for USB supporting modules such as media players. In situations when general system functionalities are required, typically firmware updates, this USB slot should be connected to the main MFA system. Toggling between Module (Slot 1) and main MFA functionality is done by pressing the rotary dial.

**Save:** The complete configuration of the amplifier can be saved to a file by using the 'Save' button. This way, a backup for system recovery can be made. This provides a great advantage for re-loading a previous configuration and duplicating the configuration to other amplifiers.

#### SAVE

When a system backup settings file is saved, it will be stored on the inserted medium in the filepath ...\\AUDAC\\SETTINGS\\SETTINGS.SET. Any available file with the same path and filename will be overwritten.

The message 'Settings saved' will be displayed on the menu once successfully saved.

**Load:** Different types of configuration files can be loaded into the amplifier, such as loudspeaker presets (\*.SPF) and system backups (\*.SET). Each of above configuration files have their own file type and will be loaded in a different way. When pressing the load button, a window will appear whereby browsing through the files on the inserted medium is possible. Browsing through folders is done by turning the rotary dial, lower folders can be accessed through selecting them and browsing a level up is possible through pressing the back arrow button. After the desired file has been found, it can be loaded by selecting it.

Speaker presets are files in \*.SPF format which are prepared and provided by AUDAC and containing all parameters for optimal performance and protection for the corresponding loudspeaker. The \*.SPF file will be loaded to the channel (Amplifier channel or Line out) which was active in the main menu most recently. Once the \*.SPF file is loaded successfully, the message 'Settings loaded' will be displayed on the menu.

System backups are files in (\*.SET) format which can be created by the user. When a system backup is made using the 'save' action as explained above, it will be saved as a (\*.SET) file which can be re-loaded in similar way as a \*.SPF file. It will be immediately loaded without requiring channel selection where it should apply to.

**Admin key:** A USB key offering administrator access to the MFA amplifier can be created when selecting the 'Admin key' function (in case the USB is connected to the MFA, not the module). A file containing the configured password information will be stored to the USB, providing instant access to the functions when this USB is inserted. This will allow instant and easy access in any circumstance, without the need for manually entering the password to the device.

**Time server:** When a module is installed which requires time server synchronisation (e.g. FMP40 voice file player for announcements at timed moments) the MFA requires synchronization from a time server. In the default configuration, an internet timeserver is being used which always guarantees an accurate synchronization of the system according to GMT. Depending of the time zone and/or location, the GMT offset settings have to be made accordingly.

In case your system is restricted from access to internet, the MFA timeserver settings should be configured to look for a local time server in stead of the internet timeserver. To do this the internet timeserver setting should be turned "Off" and the IP of the local timeserver should be configured manually. The procedure of entering a timeserver IP is identical to standard IP settings, which are described in the 'IP settings' chapter of this instruction manual.

### **Front control > Settings > General settings > Update:**

The MFA is supporting OTA (over-the-air) updates, meaning that the device automatically searches for updates which are distributed from the Audac servers over the internet to the amplifier. If any update becomes available, it will be automatically downloaded to the device and the firmware will be updated when approved and confirmed by the user (depending on the configured settings).

Updates are made and distributed frequently. Firmware updates usually include bugfixes, new and improved features and compatibility improvements with other Audac devices. So as to always have the best experience it is important that the system is kept up to date.

The update menu contains various configurable settings:

**Check for update:** This setting is default set to 'On', meaning that the device will search for available firmware updates over the internet, and in case any update becomes available it will automatically be downloaded to the system.

**Confirm before update:** This setting is default set to 'On', meaning that if any update is available and downloaded, it will indicate a message on the display and will wait for the user to confirm before starting the update. Custom made settings and configurations will be recovered once the updating has been done, however short interruptions in audio playback are possible when a firmware update is in progress, so updates are recommended to be made after business hours. When confirm before update is switched to 'Off', updating will start when the update is downloaded, not requiring any manual intervention but with the risk of having short interruptions in audio playback at inconvenient moments.

**Manual check for update:** When selected, the MFA will connect to the update server and check whether there is any update version of the firmware available for download.

**Force update:** Will re-write the firmware of the device, no matter whether there is a newer version of the firmware available at this moment. This can be useful if an earlier update was interrupted or not successful.

**Front control > Settings > General settings > Dante:**

Will indicate whether there is any Dante network interface card installed, and indicate the firmware version of the installed Dante network card (if any).

**Front control > Settings > General settings > Wall panel:**

This menu allows to assign the connected (MWX45) wall panels (multiple wall panels can be daisy-chained on the RS-485 databus) to one of both zones (amplified output or zone output).

Select the zone (Amplifier / Line out) to be controlled with the corresponding wall panel, and click the 'Set Zone' button. The selected output number will start to blink on the display of the wall panel, and after pressing the upper button on the desired wall panel, it will be assigned to the selected zone.

Simply repeat this action for each connected wall panel in your system.

**Front control > Settings > General settings > Factory reset:**

The factory settings function will reset all the device settings to factory defaults. It will recall the original factory settings and all previously made settings will be lost.

# Chapter 4

## Setting up the system

### ATTENTION

Make sure the power of the device is turned OFF before any connections or wiring adjustments are made. Disregarding this rule can lead to permanent damage of the equipment.

### 1) Connecting the loudspeakers

The loudspeakers should be connected to the 4-pin terminal block connector on the rear panel of the amplifier. Selection can be made between low impedance or constant voltage (100V / 70V) depending on project requirements. The corresponding terminals and settings shall be connected depending of the loudspeakers and installation type.

The table below shows the output voltage, impedance and maximum power load for each amplifier model.

MFA208	4Ω/12.7V	8Ω/17.9V	16Ω/25.3V	62.5Ω/70V	125Ω/100V	80W
MFA216	4Ω/17.9V	8Ω/25.3V	16Ω/35.8V	31.25Ω/70V	62.5Ω/100V	160W

For operation in low impedance mode, any loudspeaker (or combination) with an impedance higher or equal to 4Ω can be connected.

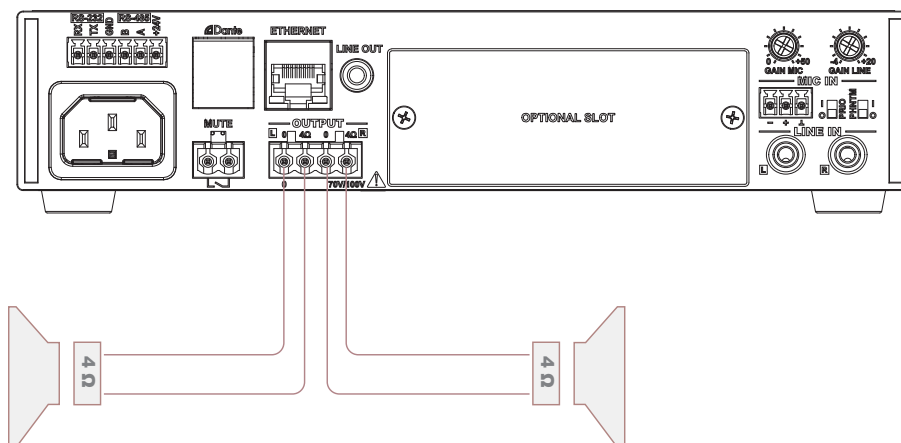

### NOTE

The output power in low impedance stereo mode is equal when used with 4Ω, 8Ω or 16Ω loads. This might look uncommon and strange, however these figures are true and correct. The output voltage is increased at higher load impedances to guarantee the maximum output power is achieved. These figures are depending of a correct output setting configuration in the 'Settings' > 'Amplifier' > 'Output' and 'Output type' menu.

For use in constant voltage (100V / 70V ) audio distribution systems, all speakers shall be connected in parallel on the corresponding output terminals, non exceeding the maximum wattage / minimum impedance of the amplifier.



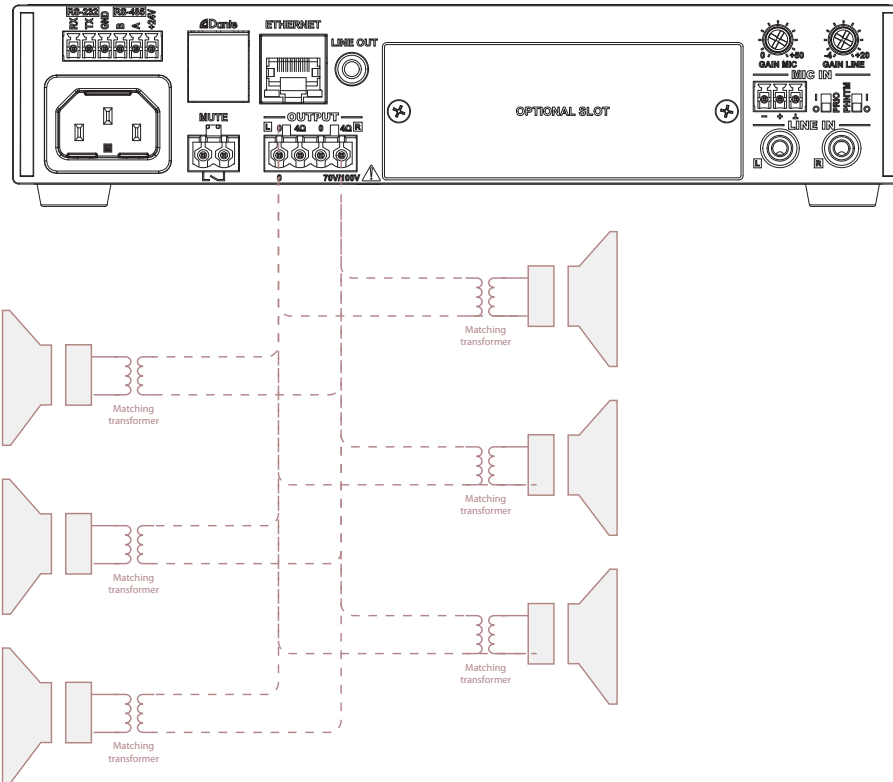

Depending on the chosen connection method (low impedance or constant voltage), the output configuration setup shall be configured accordingly.

Output configuration settings are made in the amplifier menu under 'Settings' > 'Amplifier' > 'Output' and 'Output type'. Selection can be done for 100V, 70V, 4Ω, 8Ω and 16Ω output types. The correct output setting is important to make sure all configured limiter settings are working correctly.

## 2) Connecting the audio sources

The next step is making the input signal connections. Depending on the source type and signal level (microphone or line), they need to get connected to the matching inputs. Slowly raise the master volume control until the desired sound level is achieved. Depending of the output level of the connected music sources, the input gain might need adjustment. Adjust these trimmers on the rear panel until the desired level is achieved.

The best signal to noise ratio is achieved when the master volume control of the amplifier is set near maximum position and the peak signal indicator is illuminating frequently without illuminating the clip LED indicator. If the signal sounds too loud or distorted, use the input level controls to attenuate as necessary to achieve the desired output level.

In case an internal SourceCon™ module is required as audio source, refer to the chapter 5 of this instruction manual.

## 3) Priority, phantom & muting

The microphone input contains priority (PRIO) and phantom power (PHNTM) dip switches. Enable these switches according to the connected input sources and project requirements. The phantom power switch enables 15 Volts phantom power supply for powering condenser microphones and a priority switch eliminates other connected audio sources once a signal is present on this input. When priority is enabled, this input has overall priority over all other inputs and also overrides the priority mute. More settings regarding priorities can be made through software configuring.

The priority mute contact mutes the music at the presence of a contact closure between both terminals.

## 4) Advanced software configuration settings

Multiple advanced software configuration possibilities are available, depending on project specific requirements. Configuration is done through the front panel control interface or the AUDAC Touch™ 2 application. All configurable possibilities can be found in earlier chapters of this instruction manual.

# Chapter 5

## Installing the SourceCon™ module

### CAUTION



Before installing any modules to the expansion slot of the MFA, make sure the AC mains power is disconnected. Malfunctions or electrical shocks may occur otherwise.

### Step 1:

Make sure that the slot where the module shall be installed is open and ready for installation. In standard (factory default) configuration, the MFA comes delivered with the slot covered by a blind panel. The blind panel should be removed by releasing the screws on both ends.

### Step 2:

Before removing the modules from their protective bag, we recommend touching the grounded metal chassis of the MFA (or any other grounded point) to prevent electrostatic discharges affecting the sensitive electronic components. It is recommended to always hold the module card by the metal panel and avoid touching of the components on the circuit board directly.

### Step 3:

Align both edges of the module with the guide rails inside the slot and carefully insert the module into the slot. It should slide into the slot without any considerable resistance when well positioned into the guide rail.

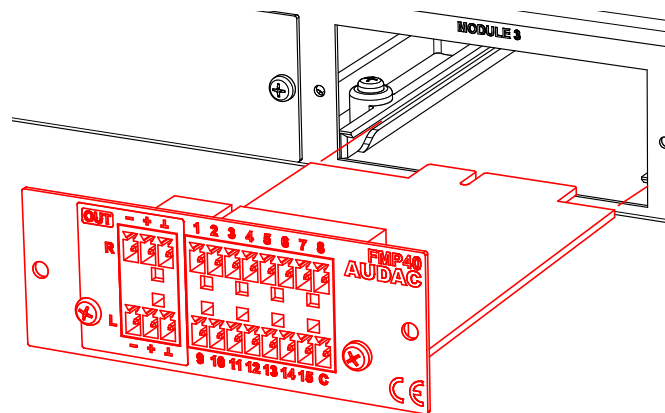

**Step 4:**

Some resistance might occur when the module's board edge connector reaches the connection counterpart on the main board. Gently push the module all the way into the slot to ensure that the contacts are correctly inserted. The module is well inserted when its connection panel touches the chassis of the main device.

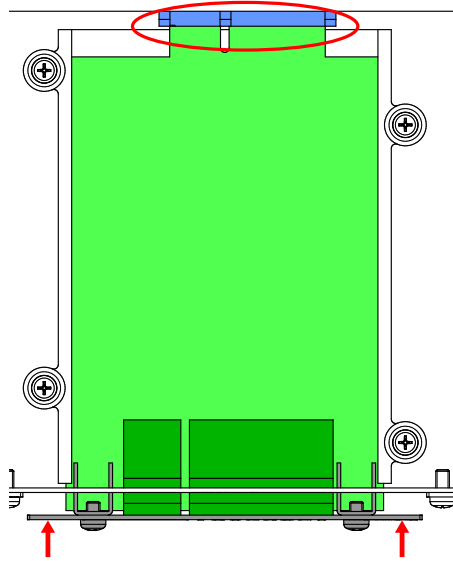

**Step 5:**

Fasten the module into the slot using the included screws. Be aware that damage or malfunctions may occur if the module is not correctly fastened.

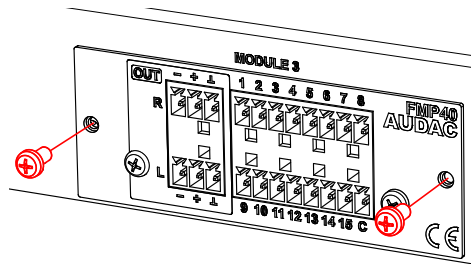

**Step 6:**

Once the modules is installed, the system can be powered on and the module will be automatically discovered by the system software. The audio signal is internally routed to the system, and no external audio connections between the SourceCon™ module and the MFA inputs are required.



# Chapter 6

## Additional information

### Technical specifications

Output power (1 kHz, THD 1%)	MFA208	@ 4Ω Stereo	2 x 40 Watt
		@ 8Ω Stereo	2 x 40 Watt
		@ 16Ω Stereo	2 x 40 Watt
		@ 70/100V Bridged	1 x 80 Watt
	MFA216	@ 4Ω Stereo	2 x 80 Watt
		@ 8Ω Stereo	2 x 80 Watt
		@ 16Ω Stereo	2 x 80 Watt
		@ 70/100V Bridged	1 x 160 Watt

**NOTE:** The powers shown for low impedance stereo mode may look strange to be equal for 4Ω, 8Ω and 16Ω loads, however these figures are true and correct. The output voltage is increased at higher load impedances to guarantee the maximum output power is achieved. These figures are depending of a correct output setting configuration in the 'Settings' > 'Amplifier' > 'Output' and 'Output type' menu.

Inputs	Mic in	Type	Balanced microphone (or mono line)
		Connector	3-pin terminal block ~ 3.81 pitch
	Sensitivity	0 dB ~ -50 dBV	
	Other	Phantom power (15V DC)	
	Priority		
Line in	Type	Unbalanced stereo line	
	Connector	RCA (2x)	
	Sensitivity	+4 dB ~ -20 dBV	
Front line input	Type	Unbalanced stereo line Combined with Line in (RCA)	
	Connector	3.5 mm stereo jack	
Module	Type	SourceCon™ interface card slot (1x)	
Priority mute contact	Type	Priority mute 2-pin terminal block ~ 5.08 mm pitch	
Controls		Front panel RS-232 RS-485 TCP/IP AUDAC Touch™ 2	
Outputs	Loudspeaker	Type	Loudspeaker output connection
		Connector	4-pin terminal block ~ 5.08 pitch
Line out	Type	Line-out connection	
	Connector	3.5 mm stereo jack	

Frequency response		100V 4 Ω 8 Ω	50 Hz – 19 kHz (–3dB) 42 Hz – 15kHz (–3dB) 23 Hz – 20kHz (–3dB)
Signal to Noise ratio			> 90 dB
Total Harmonic Distortion + Noise			< 0.1%
Crosstalk			> 70 dB
Indicators			Power Protect Clip –20 dB Signal
Protection			DC–short circuit Over heating Over load
Cooling system			Convection cooled
Amplifier technology			Class–D
Power supply		Type Range	Switching mode 100–240 V AC – 50/60 Hz
Power consumption	Standby Idle		9.5 Watt 16.2 Watt
	1/3 Rated power	MFA208 MFA216	50 Watt 72 Watt
Operating temperature			0° ~ 40° @ 95% Humidity
Dimensions			218 x 44 x 300 mm
Unit height			1 HE
Weight		MFA208 MFA216	2.2Kg 2.35 Kg
Optional accessories (external)			MBS310 Rack mount kit For single (10.5”) and side–by–side (19”) mounting MWX45 Wall panel
Optional modules (internal)			ANI44 Dante network interface (4 in / 4 out) All available SourceCon™ modules



