

AVTEK

WallMount Pro

Uchwyt ścienny do projektora

Projector Wall Mount

Projektor Wandhalterung

Support mural pour projecteur

Držák širokoúhlého projektoru

Držiak na širokougľý projektor

Fali tartó a projektorhoz

Настенный кронштейн для проектора

Suport de perete pentru proiector



avtek

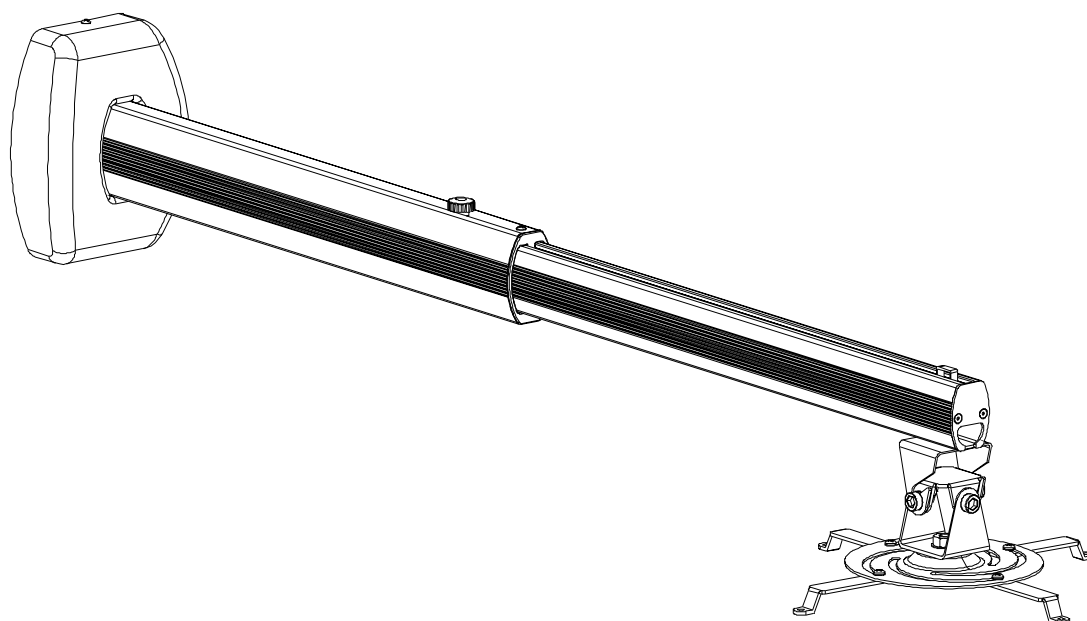

PL	Instrukcja montażu	2
EN	Installation instruction.....	3
DE	Gebrauchsanweisung	4
FR	Mode d'emploi	5
CZ	Návod k montáži	6
SK	Návod na montáž	7
HU	Telepítési útmutató	8
RU	Инструкция по монтажу	9
RO	Instrucțiuni de instalare	10

Uchwyt do projektora szerokokątnego - instrukcja montażu

Model: WallMount Pro

Lista części

A 	B 	C 	D 	E 	F 	G 	H 	I 	J 	K 	L 	M
N 	O 	P 	Q 	R 	S 	T 	U 	V 	W 			

Instalacja



Uwaga!



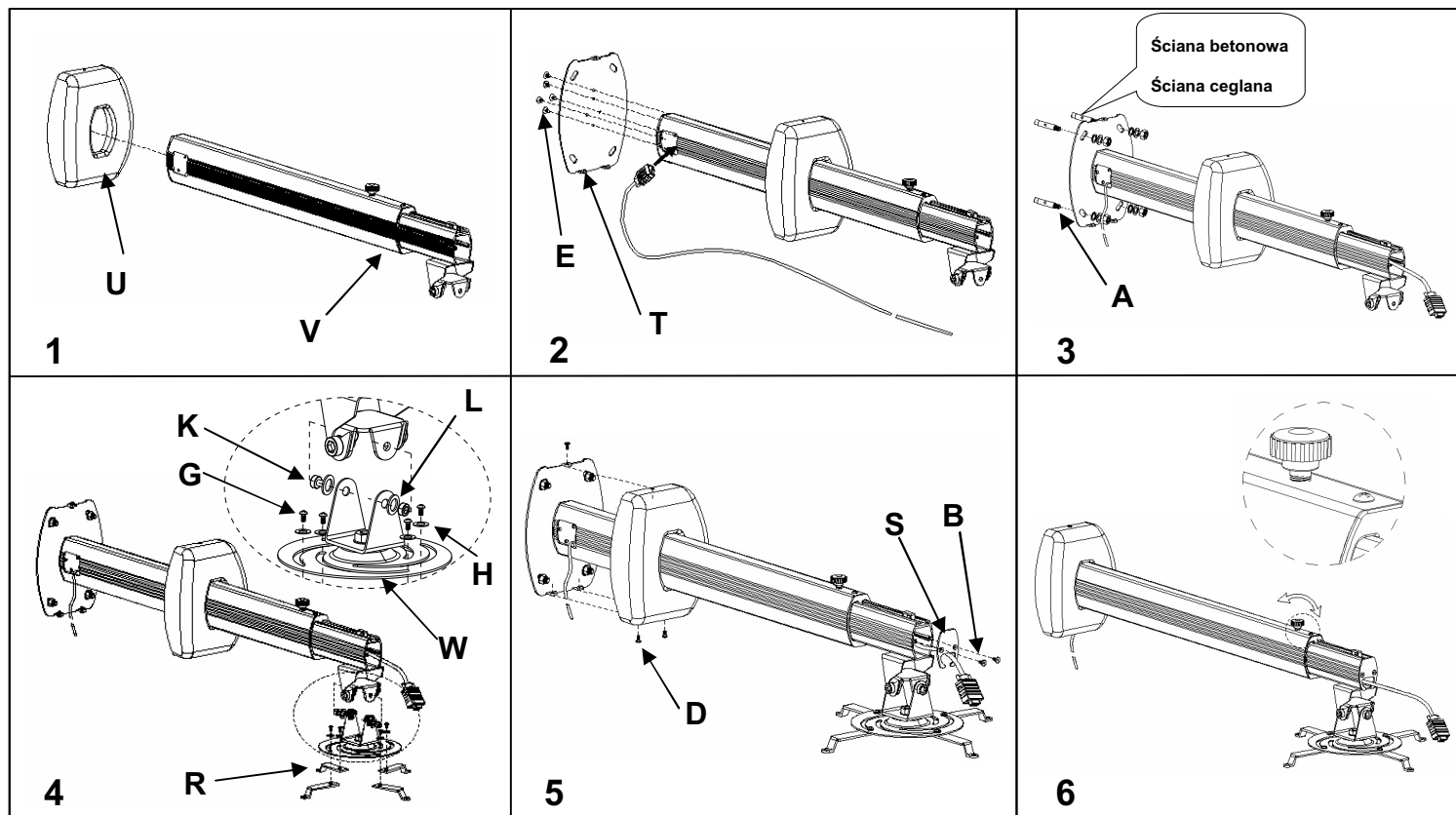

















Ten uchwyt do projektora szerokokątnego wolno instalować wyłącznie na murze ceglany lub betonowy przy użyciu załączonych przez producenta wkrętów.

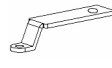

Short Throw Projector Mount Installation Instruction

Model: WallMount Pro

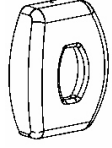
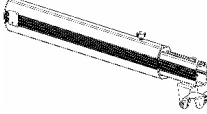
Parts List

A  M8X60 (X4)	B  M4X8 (X2)	C  S=2.5mm (X1)	D  M4X8 (X7)	E  M5X12 (X5)	F  S=3mm (X1)	G  M5X9 (X4)	H  PW6.3X13X1(X4)	I  M3X8 (X4)	J  PW3.2X10 X1(X4)	K  M8X16(X2)	L  PW8.5X19X1(X2)	M  S=6mm (X1)
N  M4 (X6)	O  M4X40 (X2)	P  M3 (X6)	Q  M3X40 (X2)	R  X4	S  X1	T  X1	U  X1	V  X1	W  X1			

Installation



Notice!



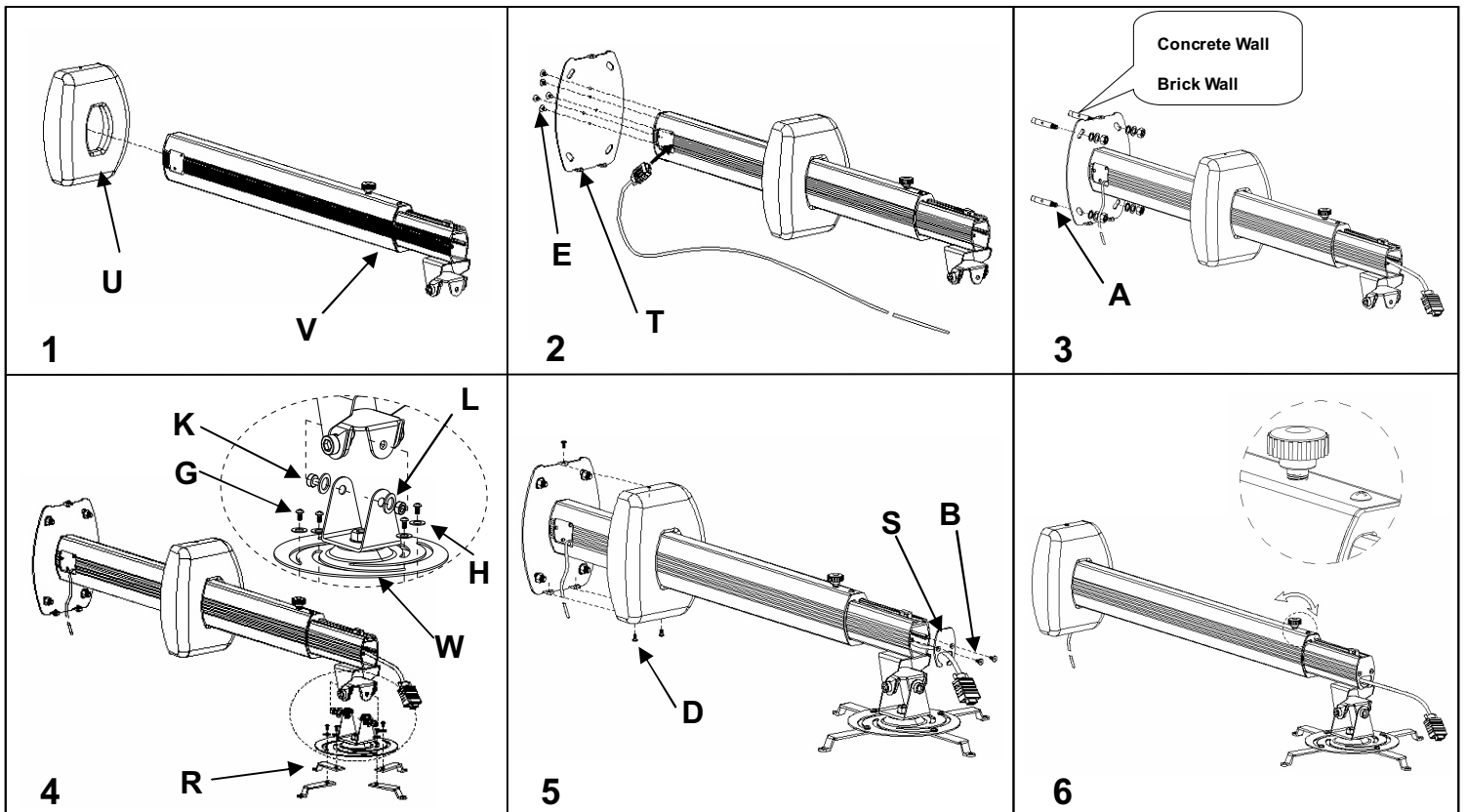

















This short throw projector mount should only be installed on concrete or brick wall with provided screws.

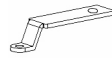

Kurz-Distanz Projektor Wandhalterung Gebrauchsanweisung

Modell: WallMount Pro

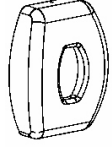
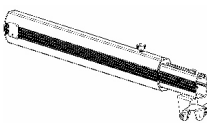
Teilliste

A  M8X60 (X4)	B  M4X8 (X2)	C  S=2.5mm (X1)	D  M4X8 (X7)	E  M5X12 (X5)	F  S=3mm (X1)	G  M5X9 (X4)	H  PW6.3X13X1(X4)	I  M3X8 (X4)	J  PW3.2X10 X1(X4)	K  M8X16(X2)	L  PW8.5X19X1(X2)	M  S=6mm (X1)
N  M4 (X6)	O  M4X40 (X2)	P  M3 (X6)	Q  M3X40 (X2)	R  X4	S  X1	T  X1	U  X1	V  X1	W  X1			

Installation



Achtung!

Diese Wandhalterung für Kurz-Distanz Projektor darf nur auf Beton- oder Ziegelwand mit den angeschlossenen Schrauben installiert werden.

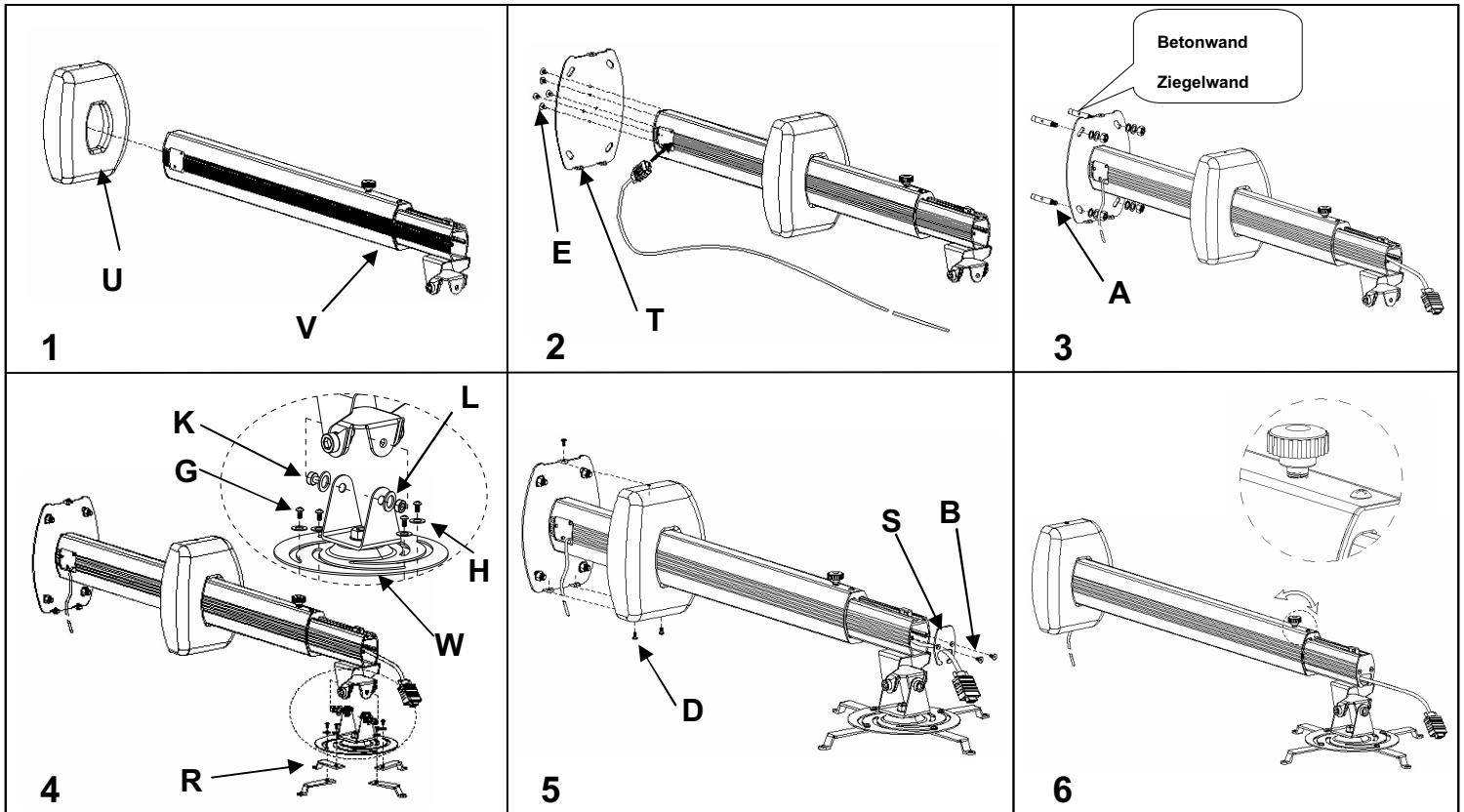

Support mural pour projecteur à focale ultra-courte

Mode d'emploi - Modèle: WallMount Pro

Liste des pièces

A M8X60 (X4)	B M4X8 (X2)	C S=2.5mm (X1)	D M4X8 (X7)	E M5X12 (X5)	F S=3mm (X1)	G M5X9 (X4)	H PW6.3X13X1(X4)	I M3X8 (X4)	J PW3.2X10 X1(X4)	K M8X16(X2)	L PW8.5X19X1(X2)	M S=6mm (X1)
N M4 (X6)	O M4X40 (X2)	P M3 (X6)	Q M3X40 (X2)	R X4	S X1	T X1	U X1	V X1	W X1			

Installation



Attention!

Ce support mural du projecteur à focale ultra-courte peut être installé uniquement sur un mur en briques ou en béton à l'aide des vis fournies par le producteur.

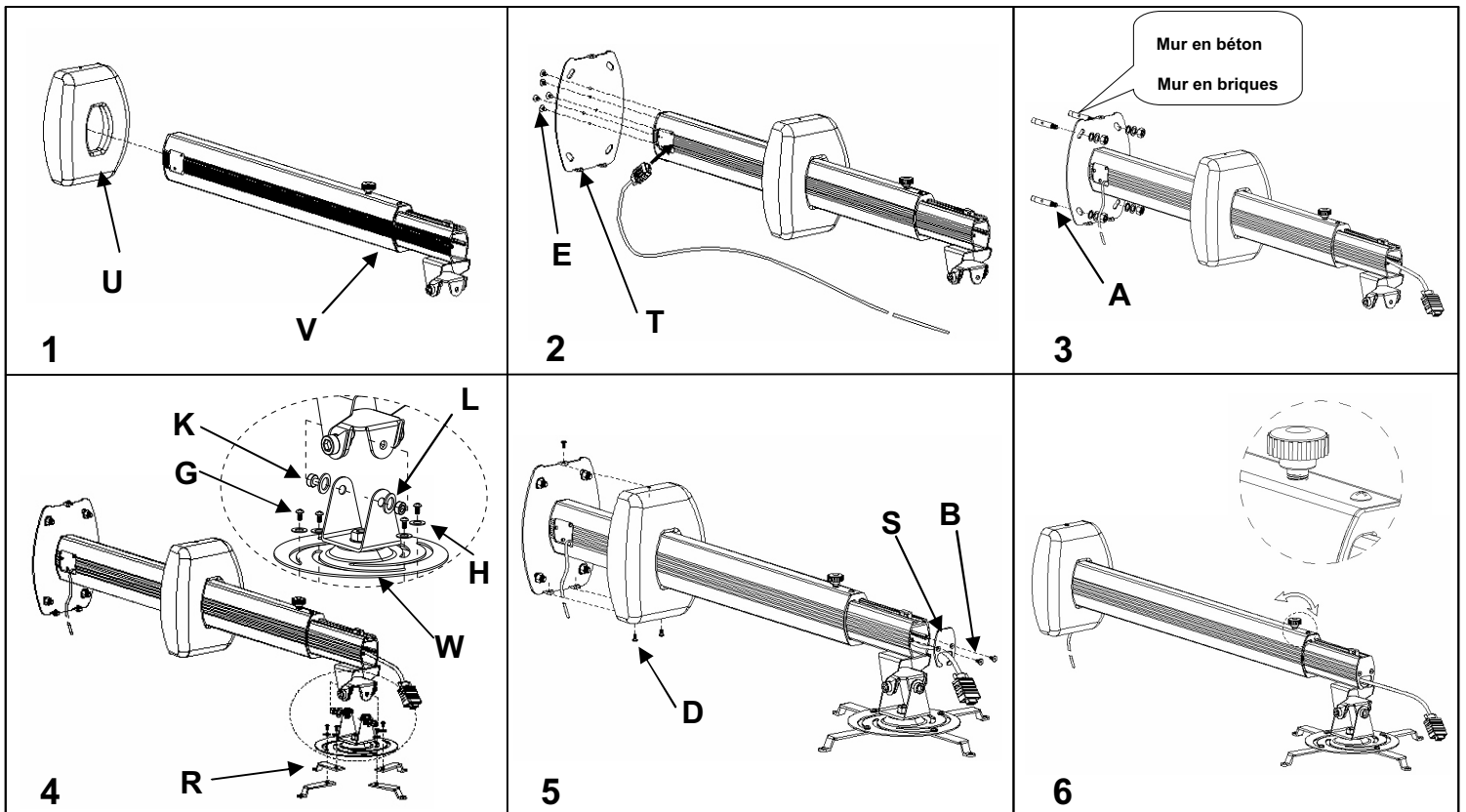

Držák širokoúhlého projektoru – návod k montáži

Model: WallMount Pro

Seznam dílů

A M8X60 (X4)	B M4X8 (X2)	C S=2.5mm (X1)	D M4X8 (X7)	E M5X12 (X5)	F S=3mm (X1)	G M5X9 (X4)	H PW6.3X13X1(X4)	I M3X8 (X4)	J PW3.2X10 X1(X4)	K M8X16(X2)	L PW8.5X19X1(X2)	M S=6mm (X1)
N M4 (X6)	O M4X40 (X2)	P M3 (X6)	Q M3X40 (X2)	R x4	S x1	T x1	U x1	V x1	W x1			

Instalace



Upozornění!



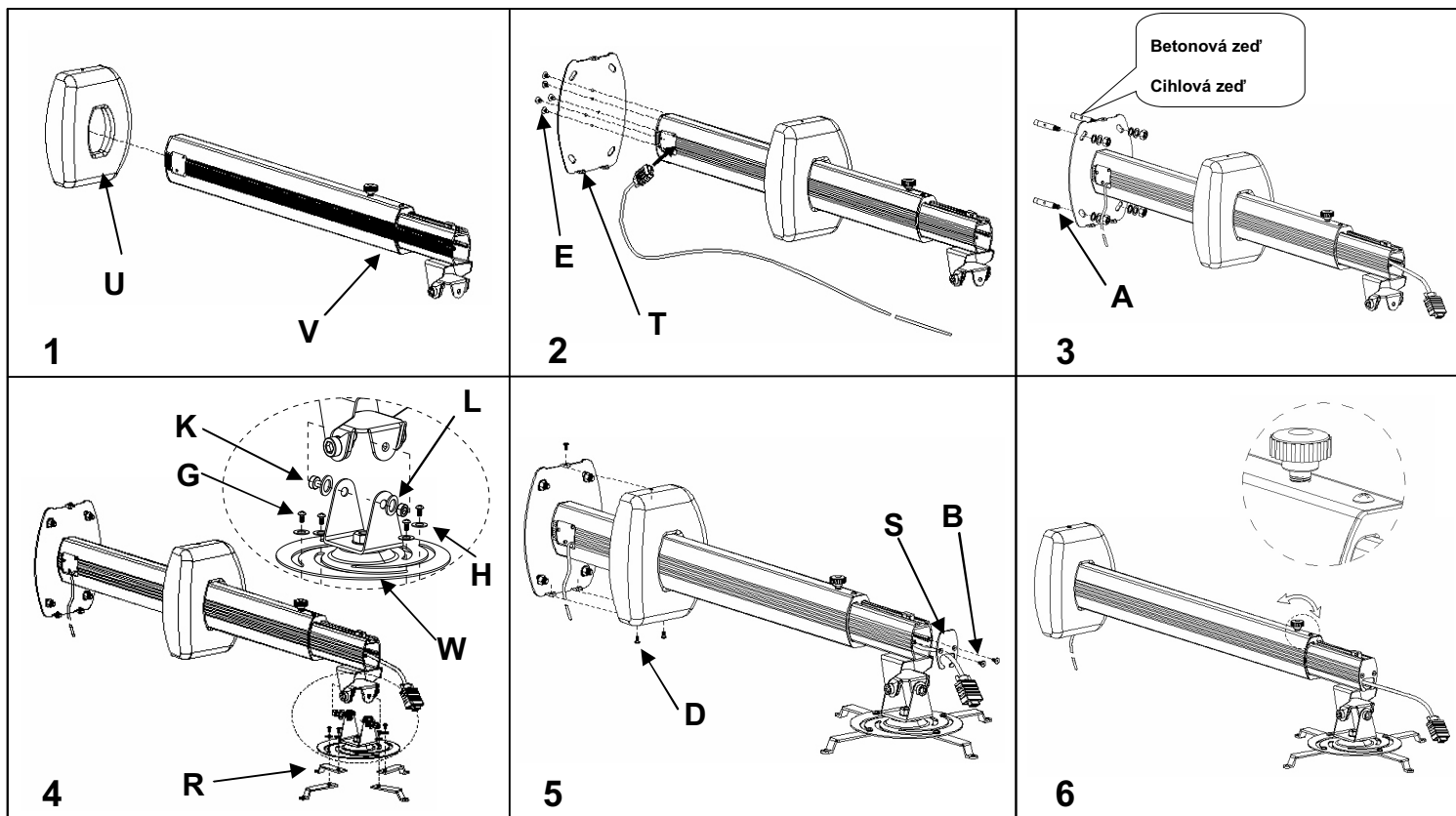

















Tento držák širokoúhlého projektoru se smí instalovat pouze na cihlové nebo betonové zdi a jen za použití výrobcem přiložených šroubů.

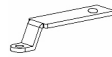

Držiak na širokouhlý projektor – návod na montáž

Model: WallMount Pro

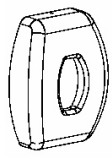
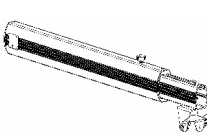
Zoznam dielov

A  M8X60 (X4)	B  M4X8 (X2)	C  S=2.5mm (X1)	D  M4X8 (X7)	E  M5X12 (X5)	F  S=3mm (X1)	G  M5X9 (X4)	H  PW6.3X13X1(X4)	I  M3X8 (X4)	J  PW3.2X10(X1)(X4)	K  M8X16(X2)	L  PW8.5X19X1(X2)	M  S=6mm (X1)
N  M4 (X6)	O  M4X40 (X2)	P  M3 (X6)	Q  M3X40 (X2)	R  X4	S  X1	T  X1	U  X1	V  X1	W  X1			

Inštalácia



Upozornenie!



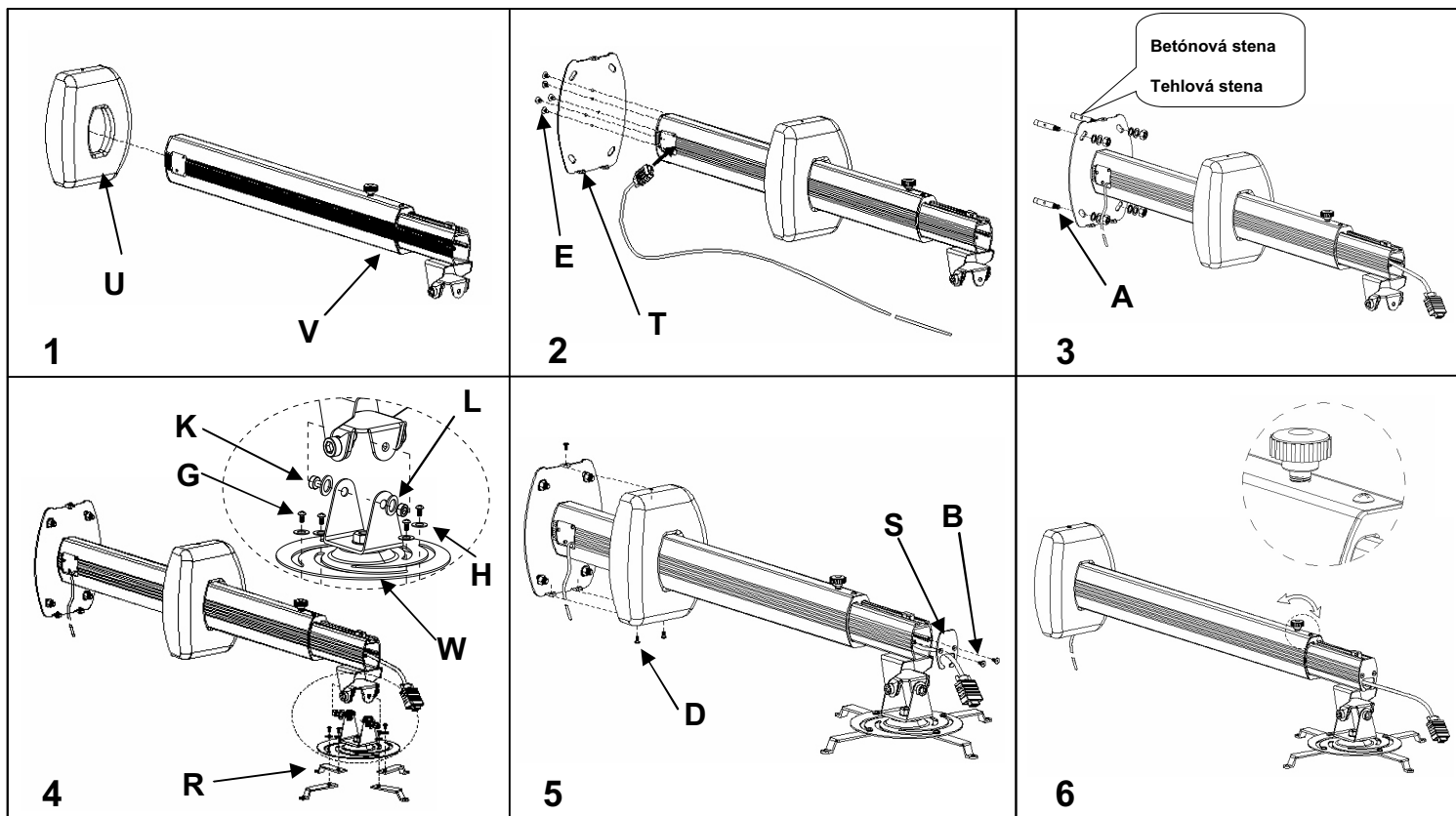

















Tento držiak na širokouhlý projektor sa smie inštalovať výlučne na tehlovom alebo betónovom múre a len s použitím výrobcom priložených skrutiek.

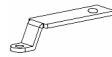

Tartó nagylátószögű projektorhoz telepítési útmutató

Model: WallMount Pro

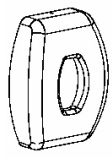
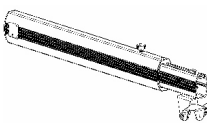
Alkatrész lista

A  M8X60 (X4)	B  M4X8 (X2)	C  S=2.5mm (X1)	D  M4X8 (X7)	E  M5X12 (X5)	F  S=3mm (X1)	G  M5X9 (X4)	H  PW6.3X13X1(X4)	I  M3X8 (X4)	J  PW3.2X10(X1)(X4)	K  M8X16(X2)	L  PW8.5X19X1(X2)	M  S=6mm (X1)
N  M4 (X6)	O  M4X40 (X2)	P  M3 (X6)	Q  M3X40 (X2)	R  X4	S  X1	T  X1	U  X1	V  X1	W  X1			

Telepítés



Figyelem!



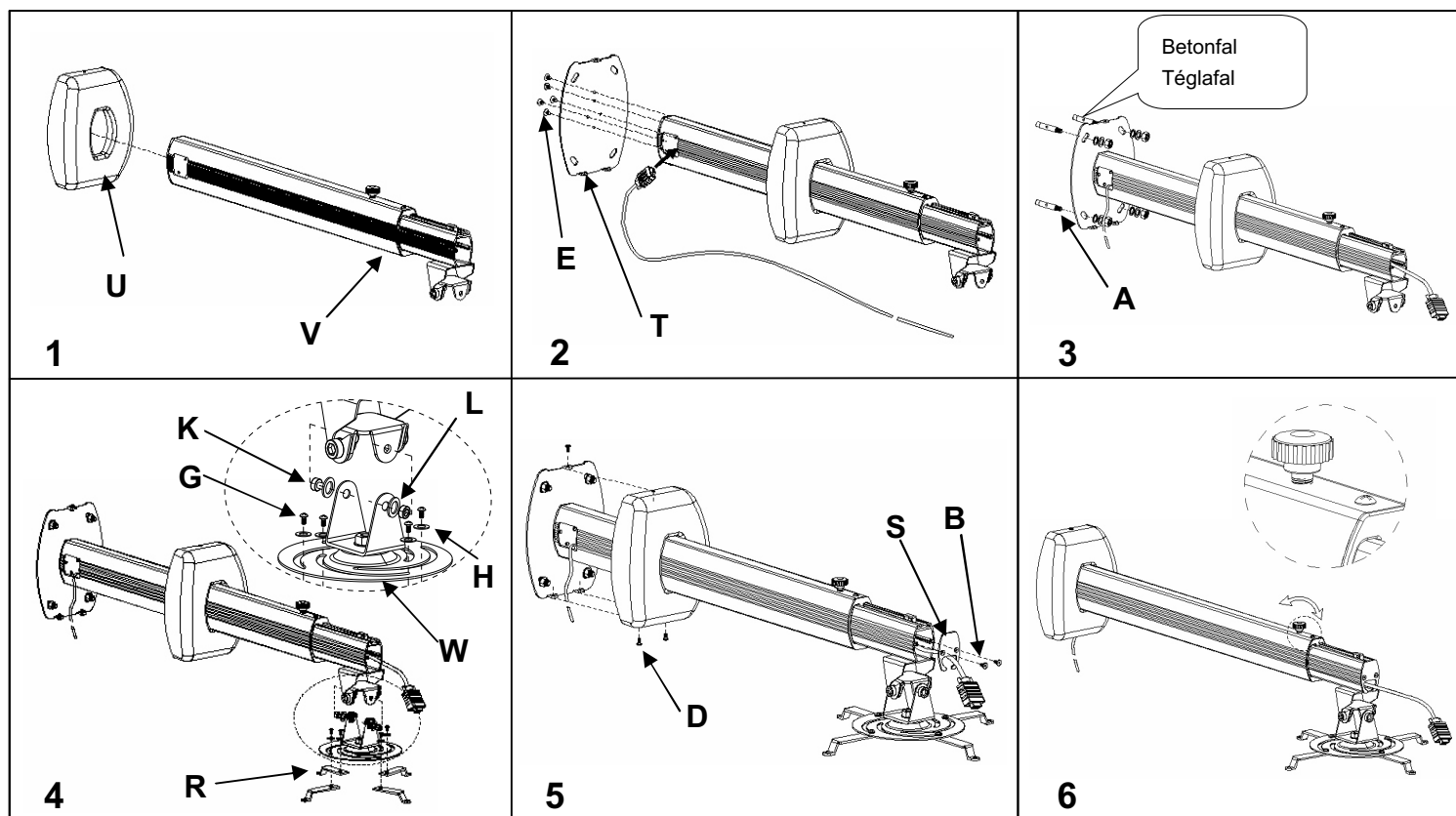

















Ezt a nagylátószögű projektorhoz való tartót kizárólag téglából vagy betonból készült falra szabad felszerelni, a gyártó által a készlethez mellékelt csavarok segítségével.

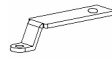

Кронштейн для широкоугольного проектора - инструкция по монтажу

Модель WallMount Pro

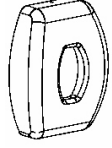
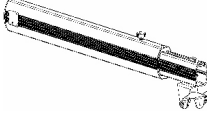
Список составляющих частей

A  M8X60 (X4)	B  M4X8 (X2)	C  S=2.5mm (X1)	D  M4X8 (X7)	E  M5X12 (X5)	F  S=3mm (X1)	G  M5X9 (X4)	H  PW6.3X13X1(X4)	I  M3X8 (X4)	J  PW3.2X10 X1(X4)	K  M8X16(X2)	L  PW8.5X19X1(X2)	M  S=6mm (X1)
N  M4 (X6)	O  M4X40 (X2)	P  M3 (X6)	Q  M3X40 (X2)	R  X4	S  X1	T  X1	U  X1	V  X1	W  X1			

Монтаж



Внимание



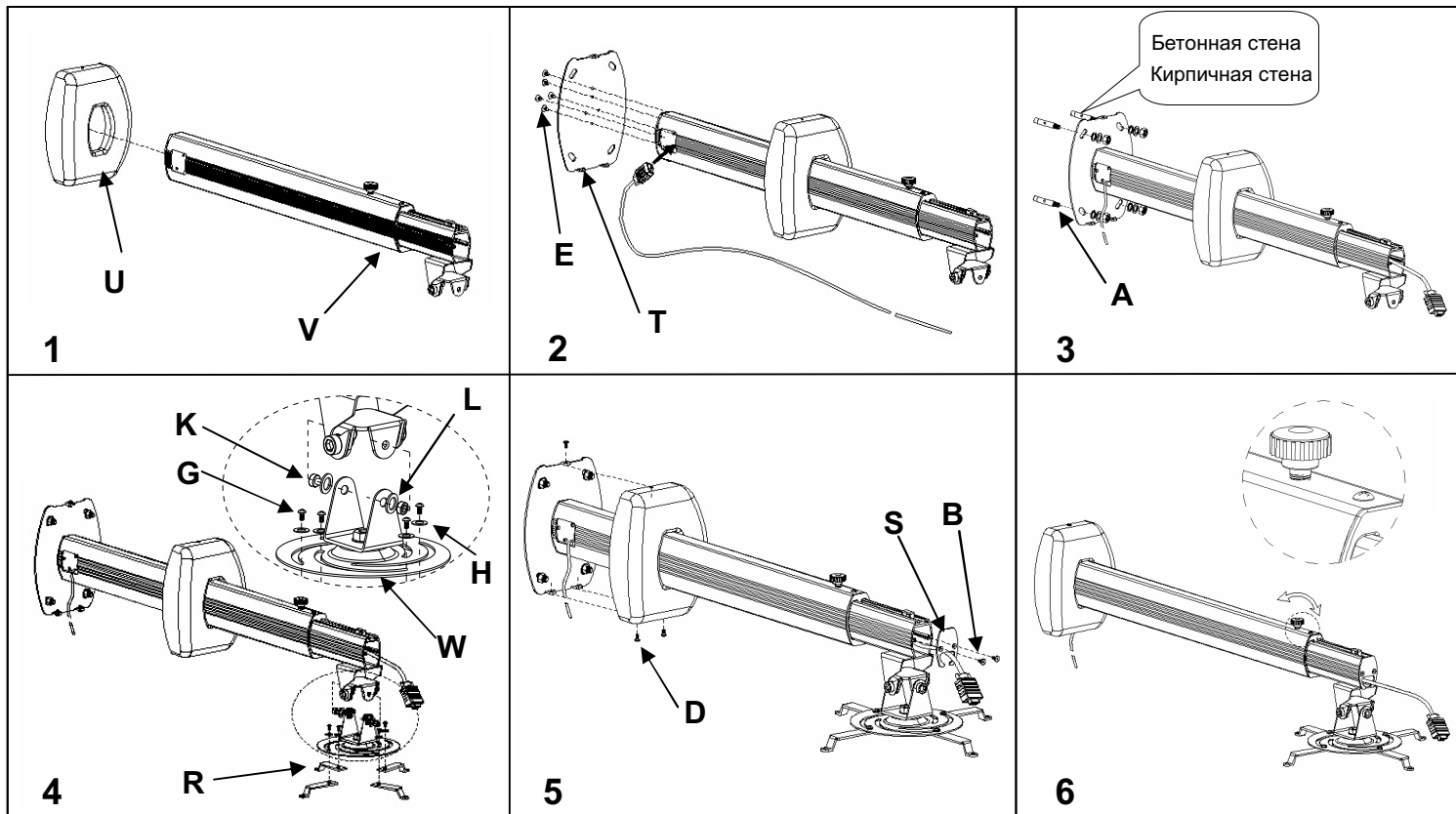

















Данный кронштейн для широкоугольного проектора можно закреплять исключительно на кирпичной или бетонной стене с помощью шурупов, прилагаемых производителем.

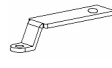

Suport pentru proiector cu unghi larg - instrucțiuni de instalare

Model: WallMount Pro

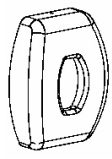
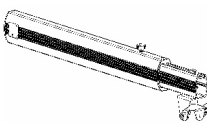
Lista pieselor

A  M8X60 (X4)	B  M4X8 (X2)	C  S=2.5mm (X1)	D  M4X8 (X7)	E  M5X12 (X5)	F  S=3mm (X1)	G  M5X9 (X4)	H  PW6.3X13X1(X4)	I  M3X8 (X4)	J  PW3.2X10 X1(X4)	K  M8X16(X2)	L  PW8.5X19X1(X2)	M  S=6mm (X1)
N  M4 (X6)	O  M4X40 (X2)	P  M3 (X6)	Q  M3X40 (X2)	R  X4	S  X1	T  X1	U  X1	V  X1	W  X1			

Instalarea



Atenție!

Acest suport pentru proiector cu unghi larg poate fi instalat doar pe perete de cărămidă sau beton cu ajutorul șuruburilor atașate de către producător.

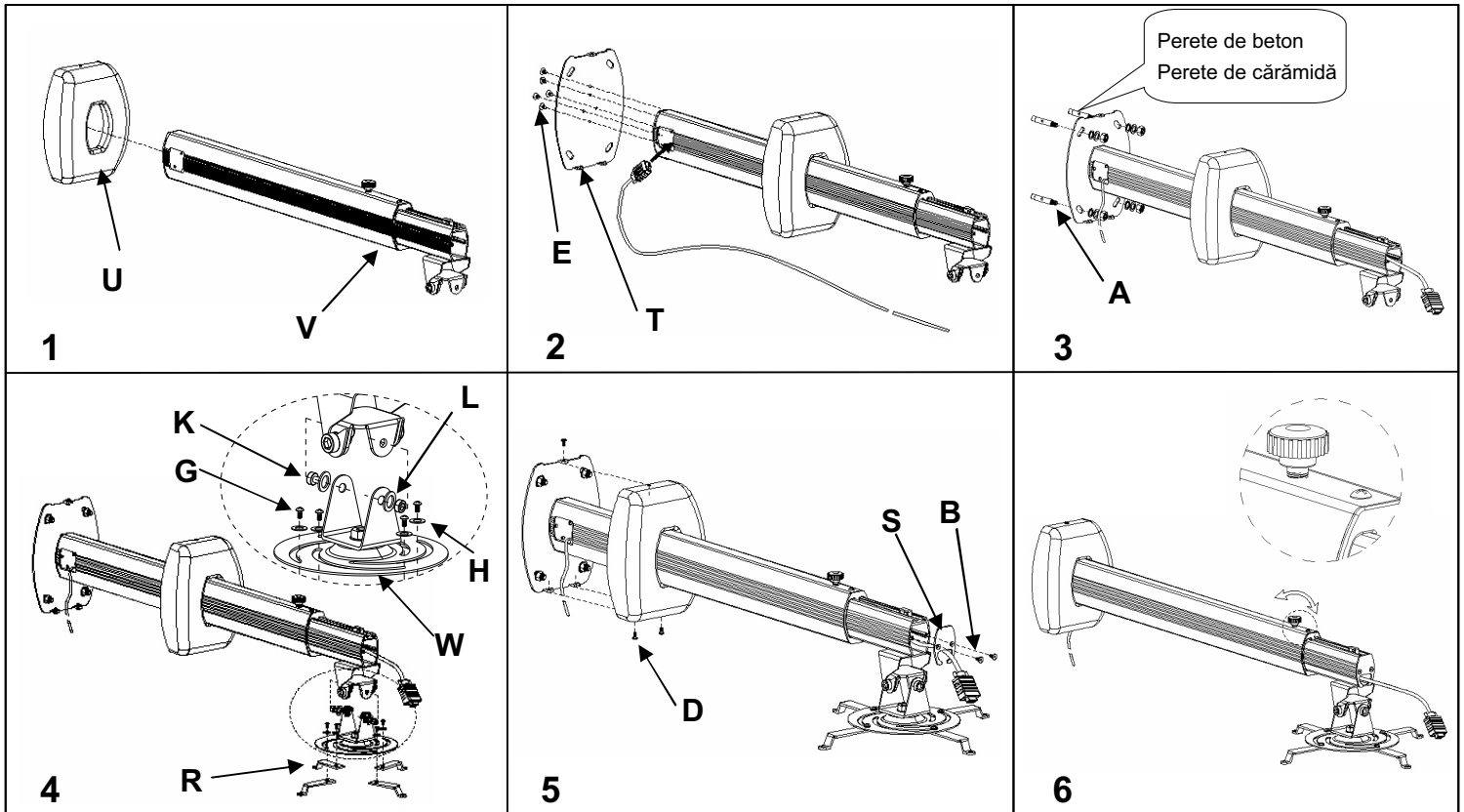



avtek

<http://www.avtek.eu>