

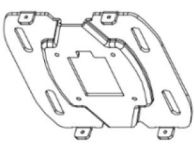

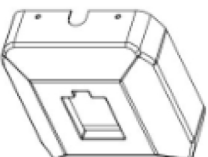







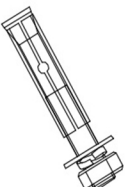

A  x1	B  x1	C  x1	D  x4	E  x1	F  x1
G  M8x60 x4	H  M5x12 x4	I  M5 x1	J  φ13x6.3x1.0 x4	K  M5x12 x4	L  M4x8 x8
M  4x6 x2	N  M8 x1	O  M4x12 x4	P  x4		

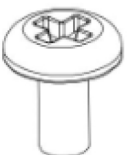

- PL** Uchwyt do projektora szerokokątnego - instrukcja montażu
- EN** Short throw projector mount installation instruction
- DE** Kurz-Distanz Projektor Wandhalterung Gebrauchsanweisung
- FR** Support mural pour projecteur à focale ultra-courte
- CZ** Držák širokoúhlého projektoru – návod k montáži
- SK** Držiak na širokouhlý projektor – návod na montáž
- HU** Tartó nagylátószögű projektorhoz – telepítési útmutató
- RU** Кронштейн для широкоугольного проектора – инструкция по монтажу
- RO** Suport pentru proiector cu unghi larg – instrucțiuni de instalare

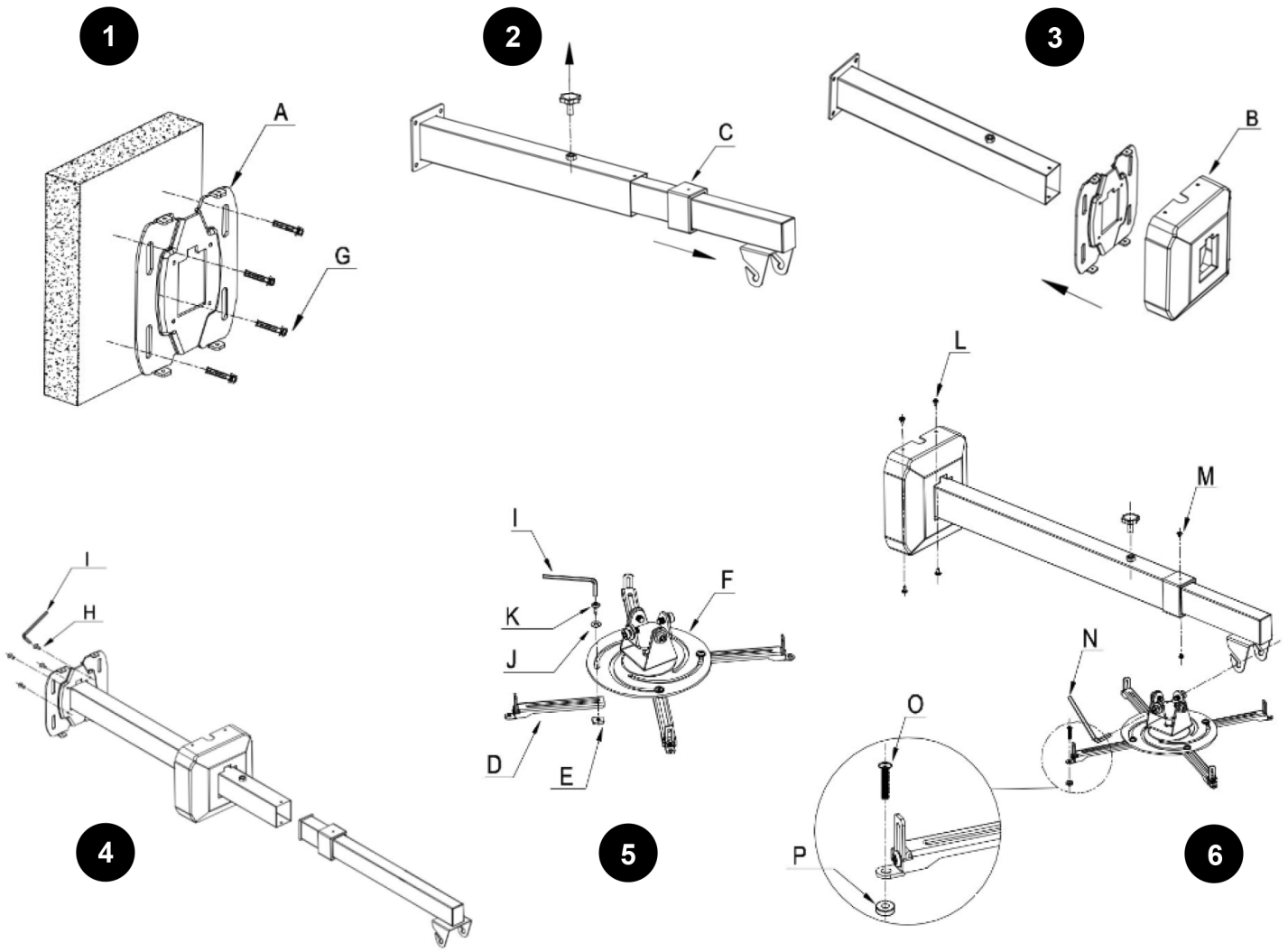

Uwaga!

PL

Ten uchwyt do projektora szerokokątnego wolno instalować wyłącznie na murze ceglanym lub betonowym przy użyciu załączonych przez producenta wkrętów.



Notice!

EN

This short throw projector mount should only be installed on concrete or brick wall with provided screws.



Achtung!

DE

Diese Wandhalterung für Kurz-Distanz Projektor darf nur auf Beton- oder Ziegelwand mit den angeschlossenen Schrauben installiert werden.



Attention!

FR

Ce support mural du projecteur à focale ultra-courte peut être installé uniquement sur un mur en briques ou en béton à l'aide des vis fournies par le producteur.



Upozornění!

CZ

Tento držák širokoúhlého projektoru se smí instalovat pouze na cihlové nebo betonové zdi a jen za použití výrobcem přiložených šroubů.



Upozornenie!

SK

Tento držiak na širokouhlý projektor sa smie inštalovať výlučne na tehlovom alebo betónovom múre a len s použitím výrobcom priložených skrutiek.



Figyelem!

HU

Ezt a nagylátószögű projektorhoz való tartót kizárólag téglából vagy betonból készült falra szabad felszerelni, a gyártó által a készlethez mellékelt csavarok segítségével.



Внимание

RO

Данный кронштейн для широкоугольного проектора можно закреплять исключительно на кирпичной или бетонной стене с помощью шурупов, прилагаемых производителем.



Atenție

RU

Acest suport pentru proiector cu unghi larg poate fi instalat doar pe perete de cărămidă sau beton cu ajutorul șuruburilor atașate de către producător.